

Operation & Maintenance Manual

D65E,P-12

D65EX,PX-12

BULLDOZER

SERIAL NUMBERS **D65E,P :60001** and up
 D65EX,PX :60001

KOMATSU

1. FOREWORD

This manual provides rules and guidelines which will help you use this machine safely and effectively. Keep this manual handy and have all personnel read it periodically. If this manual has been lost or has become dirty and can not be read, request a replacement manual from Komatsu or your Komatsu distributor.

If you sell the machine, be sure to give this manual to the new owners.

Continuing improvements in the design of this machine can lead to changes in detail which may not be reflected in this manual. Consult Komatsu or your Komatsu distributor for the latest available information of your machine or for questions regarding information in this manual.

This manual may contain attachments and optional equipment that are not available in your area. Consult Komatsu or your Komatsu distributor for those items you may require.

WARNING

- **Improper operation and maintenance of this machine can be hazardous and could result in serious injury or death.**
- **Operators and maintenance personnel should read this manual thoroughly before beginning operation or maintenance.**
- **Some actions involved in operation and maintenance of the machine can cause a serious accident, if they are not done in a manner described in this manual.**
- **The procedures and precautions given in this manual apply only to intended uses of the machine. If you use your machine for any unintended uses that are not specifically prohibited, you must be sure that it is safe for you and others. In no event should you or others engage in prohibited uses or actions as described in this manual.**
- **Komatsu delivers machines that comply with all applicable regulations and standards of the country to which it has been shipped. If this machine has been purchased in another country or purchased from someone in another country, it may lack certain safety devices and specifications that are necessary for use in your country. If there is any question about whether your product complies with the applicable standards and regulations of your country, consult Komatsu or your Komatsu distributor before operating the machine.**
- **The description of safety is given in SAFETY INFORMATION on page 0-2 and in SAFETY from page 1-1.**

2. SAFETY INFORMATION

Most accidents are caused by the failure to follow fundamental safety rules for the operation and maintenance of machines. To avoid accidents, read, understand and follow all precautions and warnings in this manual and on the machine before performing operation and maintenance.

To identify safety messages in this manual and on machine labels, the following signal words are used.

 **DANGER** — This word is used on safety messages and safety labels where there is a high probability of serious injury or death if the hazard is not avoided. These safety messages or labels usually describe precautions that must be taken to avoid the hazard. Failure to avoid this hazard may also result in serious damage to the machine.

 **WARNING** — This word is used on safety messages and safety labels where there is a potentially dangerous situation which could result in serious injury or death if the hazard is not avoided. These safety messages or labels usually describe precautions that must be taken to avoid the hazard. Failure to avoid this hazard may also result in serious damage to the machine.

 **CAUTION** — This word is used on safety messages and safety labels for hazards which could result in minor or moderate injury if the hazard is not avoided. This word might also be word for hazards where the only result could be damage to the machine.

NOTICE — This word is used for precautions that must be taken to avoid actions which could shorten the life of the machine.

Safety precautions are described in SAFETY from page 1-1.

Komatsu cannot predict every circumstance that might involve a potential hazard in operation and maintenance. Therefore the safety messages in this manual and on the machine may not include all possible safety precautions. If any procedures or actions not specifically recommended or allowed in this manual are used, you must be sure that you and others can do such procedures and actions safely and without damaging the machine. If you are unsure about the safety of some procedures, contact Komatsu or a Komatsu distributor.

3. INTRODUCTION

3.1 INTENDED USE

This Komatsu BULLDOZER is designed to be used mainly for the following work:

- Dozing
- Smoothing
- Cutting into hard or frozen ground or ditching.
- Felling trees, removing stumps

See the section "12.10 WORK POSSIBLE USING BULLDOZER" for further details.

3.2 FEATURES

HIGH PRODUCTIVITY

- Powerful S6D125(6D125 for D65E) engine and large-capacity blade provide high productivity.
- Low drive and long truck undercarriages are extraordinarily tough and offer excellent grading ability and stability.

HIGH MANEUVERABILITY

- Wrist control type single-lever for steering/directional change makes operations smooth and easy.
- Wrist control type single-lever for blade control with PPC (Proportional Pressure Control) and CLSS (Closed-center Load Sensing System) assures precise and responsive operation.
- Hydrostatic steering system (HSS) provides extra-smooth, speedy and powerful steering. (D65EX-12 and D65PX-12)

OPERATOR COMFORT

- Rubber-mounted power-train and valves substantially reduce noise and vibration.
- Pressurized cab with wide view and oil damper suspension offers a comfortable operating environment.

EASY MAINTENANCE AND HIGH DURABILITY

- Simple hull frame and monocoque track frames with pivot shafts assure greater reliability.
- Unique modular design facilitates the removal of power-train components.
- Larger-sized undercarriage components extend life.

3.3 BREAKING IN THE MACHINE

Your Komatsu machine has been thoroughly adjusted and tested before shipment. However, operating the machine under severe conditions at the beginning can adversely affect the performance and shorten the machine life.

Be sure to break in the machine for the initial 100 hours (as indicated by the service meter.)

During breaking in:

- Idle the engine for 5 minutes after starting it up.
- Avoid operation with heavy loads or at high speeds.
- Avoid sudden starts, sudden acceleration, sudden steering and sudden stops except in cases of emergency.

The precautions given in this manual for operating, maintenance, and safety procedures are only those that apply when this product is used for the specified purpose. If the machine is used for a purpose that is not listed in this manual, Komatsu cannot bear any responsibility for safety. All consideration of safety in such operations is the responsibility of the user.

Operations that are prohibited in this manual must never be carried out under any circumstances.

4. LOCATION OF PLATES, TABLE TO ENTER SERIAL NO. AND DISTRIBUTOR

4.1 MACHINE SERIAL NO. PLATE POSITION

This is at the front bottom right of the operator's seat.

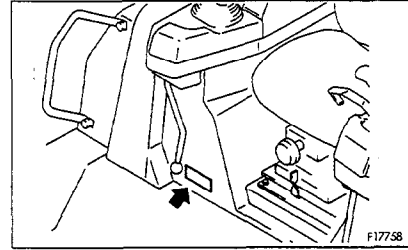

4.2 ENGINE SERIAL NO. PLATE POSITION

This is in the center of the engine cylinder block on the left side of the machine.

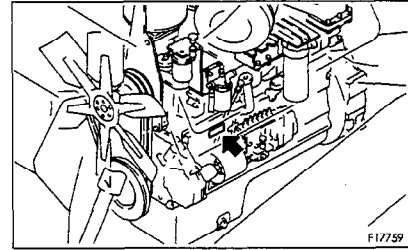

4.3 TABLE TO ENTER SERIAL NO. AND DISTRIBUTOR

Machine serial No.:	
Engine serial No.:	
Distributor name:	
Adress:	Phone:
Service personnel for your machine:	

REMARKS

5. CONTENTS

1. Foreword	0-1
2. Safety information	0-2
3. Introduction	0-3
4. Location of plates, table to enter serial No. and distributor	0-4

SAFETY

6. General precautions	1-2
7. Precautions during operation	1-9
7.1. Before starting engine	1-9
7.2. Operating machine	1-11
7.3. Transportation	1-14
7.4. Battery	1-15
7.5. Towing	1-16
8. Precautions for maintenance	1-17
8.1 Before carrying out maintenance	1-17
8.2 During maintenance	1-19
9. Position for attaching safety labels	1-24

OPERATION

10. General view	2-2
10.1. General view of machine	2-2
10.2. General view of controls and gauges	2-3
11. Explanation of components	2-6
11. 1. Front panel (meters, lamps, switches)	2-7
11. 2. Switches	2-20
11. 3. Control levers and pedals	2-22
11. 4. Fuse box	2-29
11. 5. Grease pump holder	2-30
11. 6. Shovel holder	2-30
11. 7. Door-open lock (machines equipped with cab)	2-30
11. 8. Sash glass intermediate lock (machines equipped with cab)	2-31
11. 9. Cap with lock	2-31
11.10. Hot and cool box (machines equipped with cab)	2-32
11.11. Door pocket (machines equipped with cab)	2-32
11.12. Ashtray (machines equipped with cab)	2-32
11.13. Tool box	2-32
11.14. Using car radio (machines equipped with cab)	2-33
11.15. Using car stereo (machines equipped with cab)	2-37
11.16. Handling air conditioner (machines equipped with cab)	2-43
11.17. Handling heater (machines equipped with cab)	2-47

12. Operation	2-48
12. 1. Check before starting engine	2-48
12. 2. Starting engine	2-58
12. 3. Operations and checks after starting engine	2-64
12. 4. Moving machine	2-66
12. 5. Shifting gear	2-67
12. 6. Shifting between forward and reverse	2-68
12. 7. Steering machine	2-69
12. 8. Stopping machine	2-73
12. 9. Precautions for operation	2-74
12.10. Work possible using bulldozer	2-76
12.11. Adjusting posture of work equipment	2-77
12.12. Parking machine	2-80
12.13. Check after finishing work	2-81
12.14. Stopping engine	2-82
12.15. Check after stopping engine	2-83
12.16. Locking	2-83
12.17. Tips for longer undercarriage life	2-84
13. Transportation	2-87
13.1. Loading, unloading work	2-87
13.2. Precautions for loading	2-88
13.3. Precautions for transportation	2-88
13.4. Precautions when removing work equipment	2-89
13.5. Removing cab (machines equipped with cab)	2-89
14. Cold weather operation	2-90
14.1. Precautions for low temperature	2-90
14.2. After completion of work	2-92
14.3. After cold weather	2-92
15. Long-term storage (more than one month)	2-93
15.1. Before storage	2-93
15.2. During storage	2-93
15.3. After storage	2-94
16. Troubleshooting	2-95
16.1. After running out of fuel	2-95
16.2. If battery is discharged	2-95
16.3. Other trouble	2-98

MAINTENANCE

17. Guides to maintenance	3-2
18. Outlines of service	3-5
18.1. Outline of oil, fuel, coolant	3-5
18.2. Relating to electric system	3-8
19. Wear parts list	3-9
20. Use of fuel, coolant and lubricants according to ambient temperature	3-10
21. Standard tightening torques for bolts and nuts	3-14
21.1. Introduction of necessary tools	3-14
21.2. Torque list	3-15
22. Periodic replacement of safety critical parts	3-16
23. Maintenance schedule chart	3-20
24. Service procedure	3-23
24.1. When required	3-23
24.2. Check before starting	3-42
24.3. Every 50 hours service	3-47
24.4. Every 250 hours service	3-48
24.5. Every 500 hours service	3-60
24.6. Every 1000 hours service	3-64
24.7. Every 2000 hours service	3-69
24.8. Every 4000 hours service	3-72

SPECIFICATIONS

25. Specifications	4-2
---------------------------------	-----

OPTIONS, ATTACHMENTS

26. General precautions	5-2
26.1. Precautions related to safety	5-2
27. Using seat belt	5-3
27.1. Fasten the belt and remove it in the following manner	5-3
27.2. Adjust the belt length in the following manner	5-3
28. Handling deluxe seat	5-5
29. Handling accumulator	5-7
29.1. Method of releasing pressure in operating circuit on machine equipped with accumulator	5-7

SAFETY

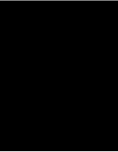

WARNING

Read and follow all safety precautions. Failure to do so may result in serious injury or death.

This safety section also contains precautions for optional equipment and attachments.

6. GENERAL PRECAUTIONS

⚠ WARNING: For reasons of safety, always follow these safety precautions.

SAFETY RULES

- ONLY trained and authorized personnel can operate and maintain the machine.
- Follow all safety rules, precautions and instructions when operating or performing maintenance on the machine.
- When working with another operator or a person on worksite traffic duty, be sure all personnel understand all hand signals that are to be used.

SAFETY FEATURES

- Be sure all guards and covers are in their proper position. Have guards and covers repaired if damaged.
Proper position → See "12.1.1 WALK-AROUND CHECK".
- Use safety features such as safety lock and seat belts properly.
- NEVER remove any safety features. ALWAYS keep them in good operating condition.
Safety lever → See "12.12 PARKING MACHINE".
Seat belts → See "27. USING SEAT BELT".
- Improper use of safety features could result in serious bodily injury or death.

CLOTHING AND PERSONAL PROTECTIVE ITEMS

- Avoid loose clothing, jewelry, and loose long hair. They can catch on controls or in moving parts and cause serious injury or death. Also, do not wear oily clothes because they are flammable.
- Wear a hard hat, safety glasses, safety shoes, mask or gloves when operating or maintaining the machine. Always wear safety goggles, hard hat and heavy gloves if your job involves scattering metal chips or minute materials — this is so particularly when driving pins with a hammer and when cleaning the air cleaner element with compressed air. Check also that there is no one near the machine.
Cleaning of air cleaner element → See "24.1 WHEN REQUIRED" in service procedure.

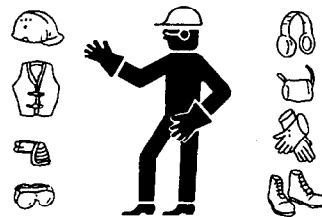

UNAUTHORIZED MODIFICATION

- Any modification made without authorization from Komatsu can create hazards.
- Before making a modification, consult your Komatsu distributor. Komatsu will not be responsible for any injury or damage caused by any unauthorized modification.

STANDING UP FROM THE SEAT

To avoid hitting unlocked operation levers, before standing up from operator's seat, do the following:

- Move steering and directional lever to neutral and move PARKING LEVER (located left of seat) to LOCK position.
- Lower equipment to ground and move SAFETY LEVER (located right of seat) to LOCK position.
Sudden and unwanted machine movement can cause serious injury or death.

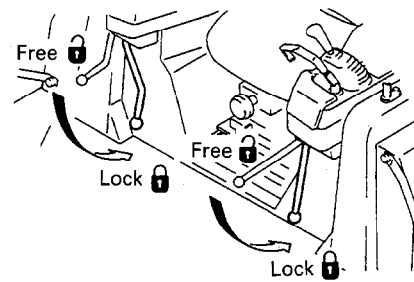

MOUNTING AND DISMOUNTING

- NEVER jump on or off the machine. NEVER get on or off a moving machine.
- When mounting and dismounting, face the machine and use the handholds steps. Maintain three-point contact to be sure that you do not fall from the machine.
- Do not hold any control levers when getting on or off the machine.
- Repair any damaged handhold or step, and tighten any loose bolts. Handholds and steps must be free of oil, grease and excessive dirt.
- When mounting or dismounting, or when moving along the top of the track, if you hold the door handle and the door is not properly closed, the door may move and cause you to fall. Always make sure that the door is properly closed.
- When mounting or dismounting, use the points marked with arrow A in the diagram below.
Use the points marked by arrow B for mounting and dismounting only when the work equipment is not installed.
Do not use the points marked by arrow C when mounting or dismounting. Use these points only when moving along the top of the track or when carrying out inspection and maintenance inside the side cover.

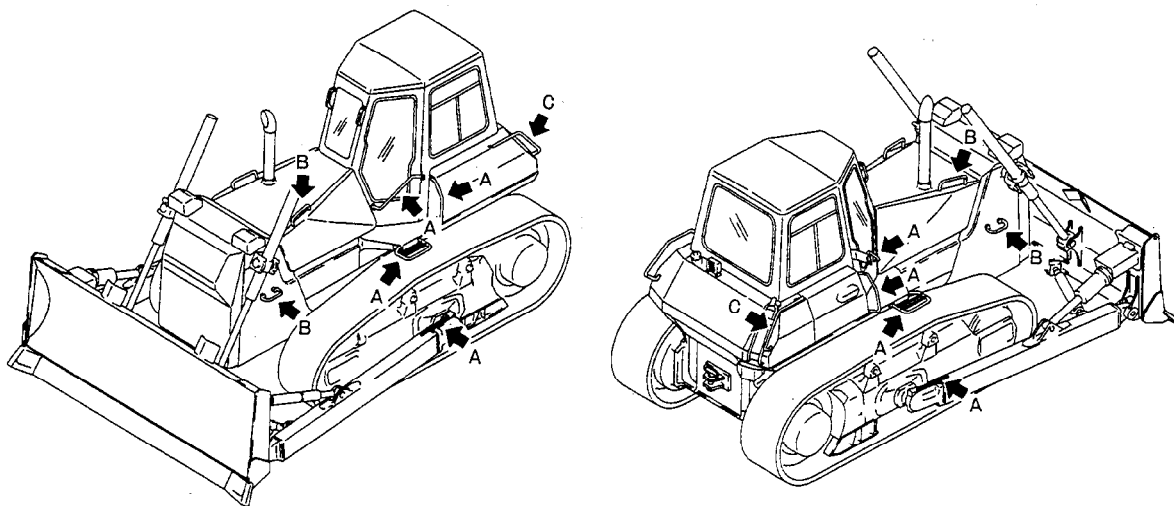

FIRE PREVENTION FOR FUEL AND OIL

Fuel, oil, and antifreeze can be ignited by a flame. Fuel is particularly **FLAMMABLE** and can be **HAZARDOUS**.

- Keep a flame away from flammable fluids.
- Stop the engine and do not smoke when refueling.
- Tighten all fuel and oil caps securely.
- Refueling and oiling should be made in well ventilated areas.
- Keep oil and fuel in the determined place and do not allow unauthorized persons to enter.



BURN HAZARD PREVENTION

- If the coolant, engine oil, power train oil or hydraulic oil is hot, use a heavy cloth, gloves, heavy clothing and safety glasses or goggles before checking or touching.
- To prevent hot water from spurting out:
 - 1) Turn engine off.
 - 2) Allow water to cool.
 - 3) Slowly loosen cap to relieve pressure before removing.
- To prevent hot oil from spurting out:
 - 1) Turn engine off.
 - 2) Allow oil to cool.
 - 3) Slowly loosen cap to relieve pressure before removing.



ASBESTOS DUST HAZARD PREVENTION

- Asbestos dust can be HAZARDOUS to your health if it is inhaled.
- If you handle materials containing asbestos fibers, follow these guidelines as given below:
 - 1) NEVER use compressed air for cleaning.
 - 2) Use water for cleaning to minimize dust cloud.
 - 3) Operate the machine with the wind to your back, whenever possible.
 - 4) Use an approved respirator if necessary.

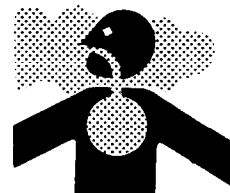
**CRUSHING OR CUTTING PREVENTION**

- Do not enter, or put your hand or arm or any other part of your body between movable parts such as between the work equipment and cylinders, or between the machine and the blade or ripper or any other attachment.
If the work equipment is operated, the clearance will change and this may lead to serious damage or personal injury.

**FIRE EXTINGUISHER AND FIRST AID KIT**

- Be sure fire extinguishers have been provided and know how to use them.
- Know where a first aid kit is located.
- Know what to do in the event of a fire.
- Be sure you know the phone numbers of persons you should contact in case of an emergency.

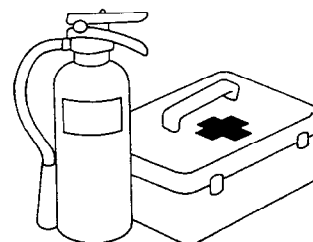

PRECAUTIONS FOR ROPS

- Do not operate machine with ROPS removed if equipped.
- The ROPS is installed to protect the operator if the machine should overturn. It is designed not only to take the load when the machine overturns, but also to absorb the impact energy.
- The Komatsu ROPS fulfills all worldwide regulations and standards, but if any unauthorized modification is carried out on it, or if it is damaged when the machine overturns, its strength will be reduced and it will not be able to provide its original capacity. It will be able to provide this capacity only if modifications and repairs are carried out in the specified way.
- When carrying out modification or repairs, always consult your Komatsu distributor first.
- Even when the ROPS is installed, if you do not fasten your seat belt securely, it cannot protect you properly. Always fasten your seat belt when operating the machine.
Seat belts → See "27. USING SEAT BELT."

PRECAUTIONS FOR ATTACHMENTS

- When installing and using an optional attachment, read the instruction manual for the attachment and the information related to attachments in this manual.
- Do not use attachments that are not authorized by Komatsu or your Komatsu distributor. Use of unauthorized attachments could create a safety problem and adversely affect the proper operation and useful life of the machine.
- Any injuries, accidents, product failures resulting from the use of unauthorized attachments will not be the responsibility of Komatsu.

MACHINES WITH ACCUMULATOR

On machines equipped with an accumulator, for a short time after the engine is stopped, if the work equipment control lever is moved to the LOWER position, the work equipment will move down under its own weight.

After stopping the engine, always place the safety lock lever in the LOCK position.

When releasing the pressure inside the work equipment circuit on machines equipped with an accumulator, follow the procedure given in the inspection and maintenance section.

Method of releasing pressure → See "29. HANDLING ACCUMULATOR".

The accumulator is filled with high-pressure nitrogen gas, and it is extremely dangerous if it is handled in the wrong way. Always observe the following precautions.

- Never make any hole in the accumulator or expose it to flame or fire.
- Do not weld any boss to the accumulator.
- When carrying out disassembly or maintenance of the accumulator, or when disposing of the accumulator, it is necessary to release the gas from the accumulator. A special air bleed valve is necessary for this operation, so please contact your Komatsu distributor.

Gas in accumulator → See "29. HANDLING ACCUMULATOR".

7. PRECAUTIONS DURING OPERATION

⚠ WARNING: Failure to follow these safety precautions may lead to a serious accident.

7.1 BEFORE STARTING ENGINE

SAFETY AT WORKSITE

- Before starting the engine, thoroughly check the area for any unusual conditions that could be dangerous.
- Before starting the engine, examine the terrain and soil conditions of the worksite. Determine the best and safest method of operation.
- If you need to operate on a street, protect pedestrians and cars by designating a person for worksite traffic duty or by installing fences around the worksite.
- If water lines, gas lines, and high-voltage electrical lines may be buried under the worksite, contact each utility and identify their locations. Be careful not to sever or cut any of these lines.
- Check the depth and flow of water before operating in water or crossing a river. NEVER be in water which is in excess of the permissible water depth.

Permissible water depth → See "12.9.2 PERMISSIBLE WATER DEPTH".

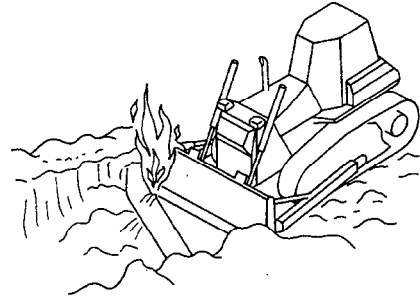

FIRE PREVENTION

- Thoroughly remove wood chips, leaves, paper and other flammable things accumulated on the engine compartment. They could cause a fire.
- Check fuel, lubrication, and hydraulic systems for leaks. Have any leaks repaired. Wipe up any excess oil, fuel or other flammable fluids.
Check points → See "12.1.1 WALK-AROUND CHECK".
- Be sure a fire extinguisher is present and working.



IN OPERATOR'S CAB

- Do not leave tools or spare parts lying around in the operator's compartment. They may damage or break the control levers or switches. Always put them in the tool box on the left side of the machine.
- Keep the cab floor, controls, steps and handholds free of oil, grease, snow, and excess dirt.
- Check the seat belt, buckle and hardware for damage or wear. Replace any worn or damaged parts. Always use seat belts when operating your machine.
Seat belts → See "27.USING SEAT BELT".

VENTILATION FOR ENCLOSED AREAS

- If it is necessary to start the engine within an enclosed area, provide adequate ventilation. Exhaust fumes from the engine can KILL.

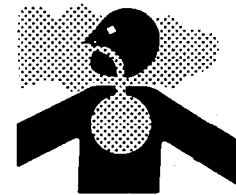

PRECAUTIONS FOR MIRRORS, WINDOWS AND LIGHTS

- Remove all dirt from the surface of the windows and lights to ensure that you can see well.
- Adjust the rear view mirror so that you can see clearly from the operator's seat, and always keep the surface of the mirror clean. If any glass is broken, replace it with a new part.
- Check that the head lamps and rear lamps are installed to match the operating conditions. Check also that they light up properly.

7.2 OPERATING MACHINE

WHEN STARTING ENGINE

- Walk around your machine again just before mounting it, checking for people and objects that might be in the way.
- NEVER start the engine if a warning tag has been attached to the control.
- When starting the engine, sound the horn as an alert.
- Start and operate the machine only while seated.
- Do not allow anyone other than the operator to ride in the cab or on the machine body.
- For machines equipped with a reverse warning buzzer, check that the warning device operates correctly.

PRECAUTIONS WHEN MOVING FORWARD OR BACKWARD

Before moving machine or its attachments:

- Honk horn to alert people nearby.
- Be sure no one is around machine, particularly behind machine.
- Use spotter if necessary, particularly if you are moving in reverse.
- When operating in areas that may be hazardous or have poor visibility, designate a person to direct worksite traffic.
- Prevent people from entering the line of travel of the machine.

Follow above even if equipped with back-up alarm and mirrors.

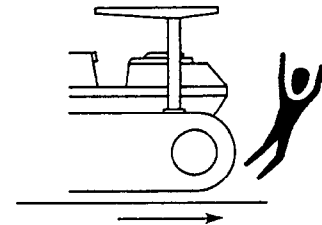

TRAVELING ON SLOPES

- Traveling on hills, banks or slopes that are steep could result in the machine tipping over or slipping.
- On hills, banks or slopes, carry the work equipment closer to the ground, approximately 20 to 30 cm above the ground. In case of emergency, quickly lower the work equipment to the ground to help the machine stop and prevent it from tipping over.
- Do not change direction on slopes. Avoid sideways travel whenever possible: rather travel up and down the slopes.
- Do not travel up and down on grass, fallen leaves, and wet steel plates. These materials may allow the machine to slip, if it is traveling sideways. Keep travel speed very low.
- When traveling downhill, drive slowly and use the engine as a brake.
- When traveling downhill with the machine being pushed by its own weight, the machine may steer in the opposite direction, so be careful when steering.
Reverse steering when traveling downhill → see “12.7.2 TURNING WHEN DESCENDING A SLOPE (D65E, P)”.

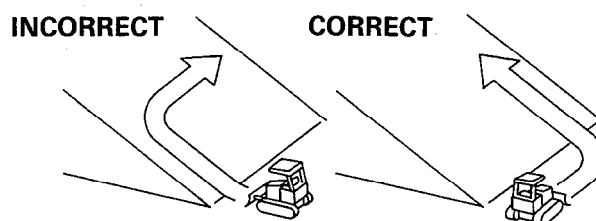

VISIBILITY

- Turn ON the head lamps and rear lamp, when working at night or at dark sites. Provide additional lights for the worksite if necessary.
- If visibility is diminished by fog, snow or rain, stop operation. Wait until there is adequate visibility for safe operation.

WORKING ON SNOWY SITE

- Snow-covered and frozen ground may allow the machine to slip sideways, even if the grade is not steep. Slow down the machine when traveling on such ground. Avoid rapid starts, stops, and steering.
- In snow removal work, pay special attention to the edge of the road and to objects under the snow.

WORKING ON LOOSE GROUND

- Avoid operating your machine too close to the edge of cliffs, overhangs, and deep ditches. If these areas collapse, your machine could fall or tip over and result in serious injury or death. Remember that the soil after heavy rain or blasting is weakened in these areas.
- Earth laid on the ground and the soil near ditches are loose. They can collapse under the weight or vibration of your machine.
- Install the HEAD GUARD or FOPS if working in areas where there is danger of falling rocks and dirt.
- When working in places where there is danger of falling rocks or danger of the machine turning over, install ROPS and a seat belt.

PARKING THE MACHINE

- Park on level ground whenever possible. If not possible, block the tracks, lower the blade to the ground and thrust the edge of the blade in the ground.

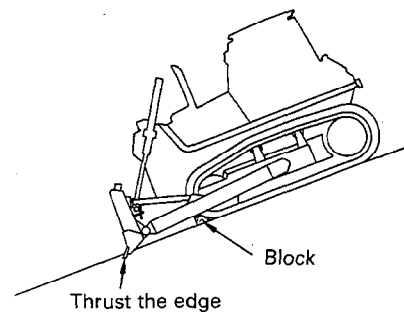

- When parking on public roads, provide fences and signs, such as flags or lights, on the machine to warn passersby to be careful. Be sure that the machine, flags or lights do not obstruct traffic.

Parking procedure → See "12.12 PARKING MACHINE".

- Before leaving the machine, lower the work equipment to the ground, move the SAFETY LEVER to LOCK position, stop the engine, and lock all the doors, windows, and covers and remove the key(s).

Work equipment posture → See "12.12 PARKING MACHINE".

Locks → See "12.16 LOCKING".

7.3 TRANSPORTATION

LOADING AND UNLOADING

- Loading and unloading the machine always involves potential hazards. **EXTREME CAUTION SHOULD BE USED.**
- Perform loading and unloading on firm, level ground only. Maintain a safe distance from the edge of a road.
- **ALWAYS** block the wheels of the hauling vehicle and place blocks under both ramps before loading and unloading.
- **ALWAYS** use ramps of adequate strength. Be sure the ramps are wide and long enough to provide a safe loading slope.
- Be sure that the ramps are securely positioned and fastened, and that the two sides are at the same level as one another.
- Be sure the ramp surface is clean and free of grease, oil, ice and loose materials. Remove dirt from the machine tracks.
- **NEVER** correct your steering on the ramps. If necessary, drive away from the ramps and climb again.
- After loading, block the machine tracks and secure the machine with tie-downs.

Loading and unloading → See "13. TRANSPORTATION."

Tie-downs → See "13. TRANSPORTATION."

CORRECT

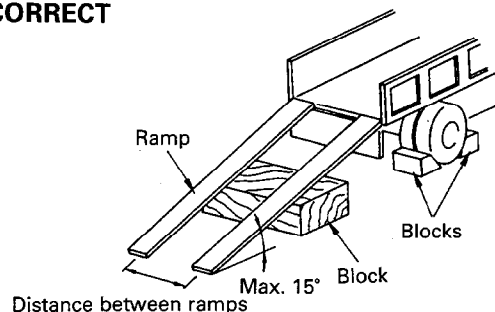

SHIPPING

- When shipping the machine on a hauling vehicle, obey all state and local laws governing the weight, width, and length of a load. Also obey all applicable traffic regulations.
- Determine the shipping route while taking into account the width, height and weight of the load.

7.4 BATTERY

BATTERY HAZARD PREVENTION

- Battery electrolyte contains sulfuric acid and can quickly burn the skin and eat holes in clothing. If you spill acid on yourself, immediately flush the area with water.
- Battery acid could cause blindness if splashed into the eyes. If acid gets into the eyes, flush them immediately with large quantities of water and see a doctor at once.
- If you accidentally drink acid, drink a large quantity of water or milk, beaten egg or vegetable oil. Call a doctor or poison prevention center immediately.
- When working with batteries. ALWAYS wear safety glasses or goggles.
- Batteries generate hydrogen gas. Hydrogen gas is very EXPLOSIVE, and is easily ignited with a small spark or flame.
- Before working with batteries, stop the engine and turn the starting switch to the OFF position.
- Avoid short-circuiting the battery terminals through accidental contact with metallic objects, such as tools, across the terminals.
- Tighten the battery terminals securely. Loosened terminals can generate sparks and lead to an explosion.
- When removing or installing, check which is the positive (+) terminal and negative (-) terminal.
- Tighten the battery cap.

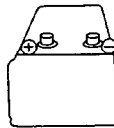
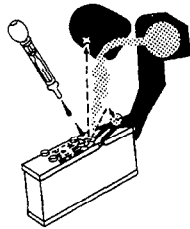

STARTING WITH BOOSTER CABLES

- ALWAYS wear safety glasses or goggles when starting the machine with booster cables.
- When starting from another machine, do not allow the two machines to touch.
- Be sure to connect the positive (+) cable first when installing the booster cables. Disconnect the ground or negative (-) cable first when removing them.
- Connect the batteries in parallel: positive to positive and negative to negative.
- When connecting the ground cable to the frame of the machine to be started, be sure to connect it as far as possible from the battery.

Starting with booster cables → See "16.2 IF BATTERY IS DISCHARGED".

INCORRECT

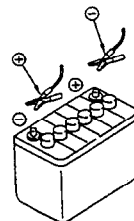

7.5 TOWING

WHEN TOWING THE MACHINE, FIX THE WIRE TO THE REAR HITCH PIN OR RIPPER.

- Injury or death could result if a disabled machine is towed incorrectly.
- If your machine is towed by another machine, ALWAYS use a wire rope with a sufficient towing capacity.
- When the machine is towed, always set the steering and directional lever to the N (neutral) position.
- NEVER allow a disabled machine to be towed on a slope.
- Do not use a kinked or frayed wire rope.
- Do not straddle the towing cable or wire rope.
- When connecting up a towing machine, do not let anyone enter the area between the towing machine and the equipment being towed.
- Set the towing machine and the towing connection of the equipment being towed in a straight line when connecting it.
- Take up the slack in the wire rope and tow the machine.

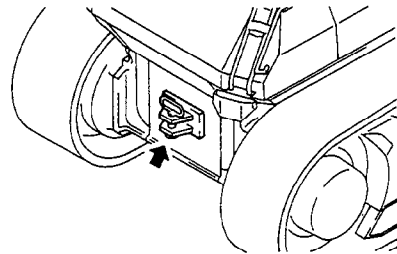

8. PRECAUTIONS FOR MAINTENANCE

⚠ WARNING: Failure to follow these safety precautions may lead to a serious accident.

8.1 BEFORE CARRYING OUT MAINTENANCE

WARNING TAG

- If others start the engine or operate the controls while you are performing service or lubrication, you could suffer serious injury or death.
- ALWAYS attach the WARNING TAG to the control lever in the operator's cab to alert others that you are working on the machine. Attach additional warning tags around the machine, if necessary.
- These tags are available from your Komatsu distributor. (Part No. 09963-03000)

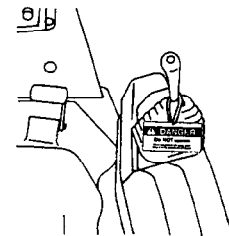

PROPER TOOLS

- Use only tools suited to the task. Using damaged, low quality, faulty, or makeshift tools could cause personal injury.
Tools → See "21.1 INTRODUCTION OF NECESSARY TOOLS".



PERIODIC REPLACEMENT OF SAFETY CRITICAL PARTS

- Replace the following fire-related components periodically:
Fuel system: Fuel hose, spilling hose, and fuel tube cap
Hydraulic system: Pump outlet hose, and front and rear pump branch hoses
- Replace these components periodically with new ones, regardless of whether or not they appear to be defective. These components deteriorate over time.
- Replace or repair any such components if any defect is found, even though they have not reached the time specified.

Replacement of safety critical components → See "22. PERIODIC REPLACEMENT OF SAFETY CRITICAL PARTS".

STOP THE ENGINE BEFORE CARRYING OUT INSPECTION AND MAINTENANCE

- Always stop the machine on firm flat ground and stop the engine before carrying out inspection and maintenance.
- If it is necessary to run the engine when carrying out maintenance, such as when cleaning the inside of the radiator, place the safety lock lever at the LOCK position and carry out the operation with two workers.
- One worker should sit in the operator's seat so that he can stop the engine immediately if necessary. He should also be extremely careful not to touch any lever by mistake. Touch the levers only when they have to be operated.
- The worker carrying out the maintenance should be extremely careful not to touch or get caught in the moving parts.
- If maintenance is carried out with the work equipment raised, always support it securely with blocks.

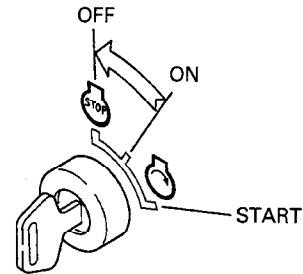

8.2 DURING MAINTENANCE

PERSONNEL

- Only authorized personnel can service and repair the machine. Extra precaution should be used when grinding, welding, and using a sledge-hammer.

ATTACHMENTS

- Place attachments that have been removed from the machine in a safe place so that they do not fall. If they fall on you or others, serious injury could result.



WORK UNDER THE MACHINE

- Always lower all movable work equipment to the ground or to their lowest position before performing service or repairs under the machine.
- Always block the tracks of the machine securely.
- Never work under the machine if the machine is poorly supported.



KEEP THE MACHINE CLEAN

- Spilled oil or grease, or scattered tools or broken pieces are dangerous because they may cause you to slip or trip. Always keep your machine clean and tidy.
- If water gets into the electrical system, there is danger that the machine may not move or may move unexpectedly. Do not use water or steam to clean the sensors, connectors, or the inside of the operator's compartment.

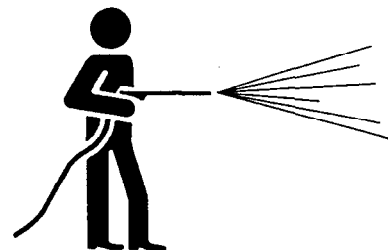

RULES TO FOLLOW WHEN ADDING FUEL OR OIL

- Spilled fuel and oil may cause you to slip, so always wipe it up immediately.
- Always tighten the cap of the fuel and oil fillers securely.
- Never use fuel for washing any parts.
- Always add fuel and oil in a well-ventilated place.

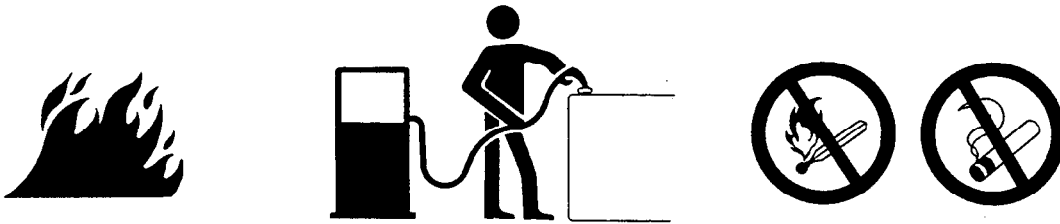

RADIATOR WATER LEVEL

- If it is necessary to add water to the radiator, stop the engine and allow the engine and radiator to cool down before adding the water.
- Slowly loosen the caps to relieve pressure before removing the caps.

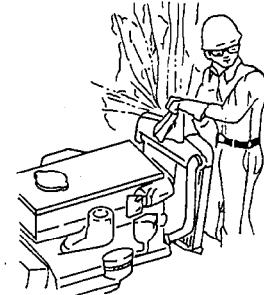

USE OF LIGHTING

- When checking fuel, oil, coolant, or battery electrolyte, always use lighting with anti-explosion specifications. If such lighting equipment is not used, there is danger of explosion.



PRECAUTIONS WITH BATTERY

- When repairing the electrical system or when carrying out electrical welding, remove the negative (–) terminal of the battery to stop the flow of current.

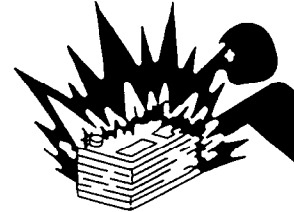

HANDLING HIGH-PRESSURE HOSES

- Do not bend high-pressure hoses or hit them with hard objects. Do not use any bent or cracked piping, tubes or hoses. They may burst during use.
- Always repair any loose or broken fuel hoses or oil hoses. If fuel or oil leaks, it may cause a fire.
- Avoid torching, soldering, or welding on pipes, tubes and equipment that contain fuel or oils. If heated, they can generate flammable fumes or mist and could cause a fire or explosion.

PRECAUTIONS WITH HIGH PRESSURE OIL

- Do not forget that the work equipment circuits are always under pressure.
- Do not add oil, drain oil, or carry out maintenance or inspection before completely releasing the internal pressure.
- If oil is leaking under high pressure from small holes, it is dangerous if the jet of high-pressure oil hits your skin or enters your eyes. Always wear safety glasses and thick gloves, and use a piece of cardboard or a sheet of wood to check for oil leakage.
- If you are hit by a jet of high-pressure oil, consult a doctor immediately for medical attention.

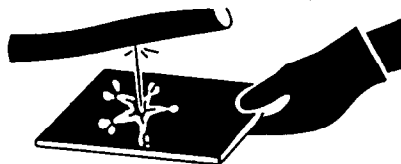

PRECAUTIONS WHEN CARRYING OUT MAINTENANCE AT HIGH TEMPERATURE OR HIGH PRESSURE

- Immediately after stopping operations, the engine cooling water and oil at all parts is at high temperature and under high pressure.
In this condition, if the cap is removed, or the oil or water are drained, or the filters are replaced, this may result in burns or other injury. Wait for the temperature to go down, then carry out the inspection and maintenance in accordance with the procedures given in this manual.

Cleaning inside or cooling system → see "24.1 WHEN REQUIRED".

Checking cooling water level, lubricating oil level → see "24.2 CHECK BEFORE STARTING".

Checking oil level in hydraulic tank, final drive case → see "24.4 PERIODIC MAINTENANCE".

Changing oil, replacing filters → see "24.5 - 7 PERIODIC MAINTENANCE".



PRECAUTIONS WHEN USING HIGH PRESSURE GREASE TO ADJUST TRACK TENSION

Grease is pumped into the track tension adjustment system under high pressure. If the specified procedure for maintenance is not followed when making adjustments, the plug or grease fitting may fly out and cause damage or personal injury.

- When loosening the grease drain plug, never loosen it more than one turn.
- Never put your face, hands, feet, or any other part of your body directly in front of any grease drain plug or valve.

Adjusting track tension → see "24.1 WHEN REQUIRED".



ROTATING FAN AND BELT

- Keep away from rotating parts and be careful not to let anything get caught in them.
- If your body or tools touch the fan blades or fan belt, they may be cut off or sent flying, so never touch any rotating parts.

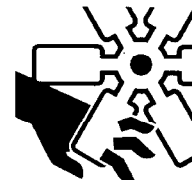

WASTE MATERIALS

- Never dump waste oil in a sewer system, rivers, etc.
- Always put oil drained from your machine in containers. Never drain oil directly on the ground.
- Obey appropriate laws and regulations when disposing of harmful objects such as oil, fuel, coolant, solvent, filters, batteries, and others.

INCORRECT

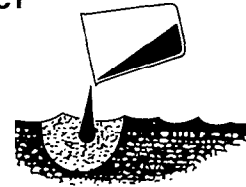

9. POSITION FOR ATTACHING SAFETY LABELS

Always keep these labels clean. If they are lost or damaged, attaching them again or replace them with a new label.

There are other labels in addition to the safety labels listed as follows, so handle them in the same way.

Safety labels may be available in languages other than English. To find out what labels are available, contact your Komatsu distributor.

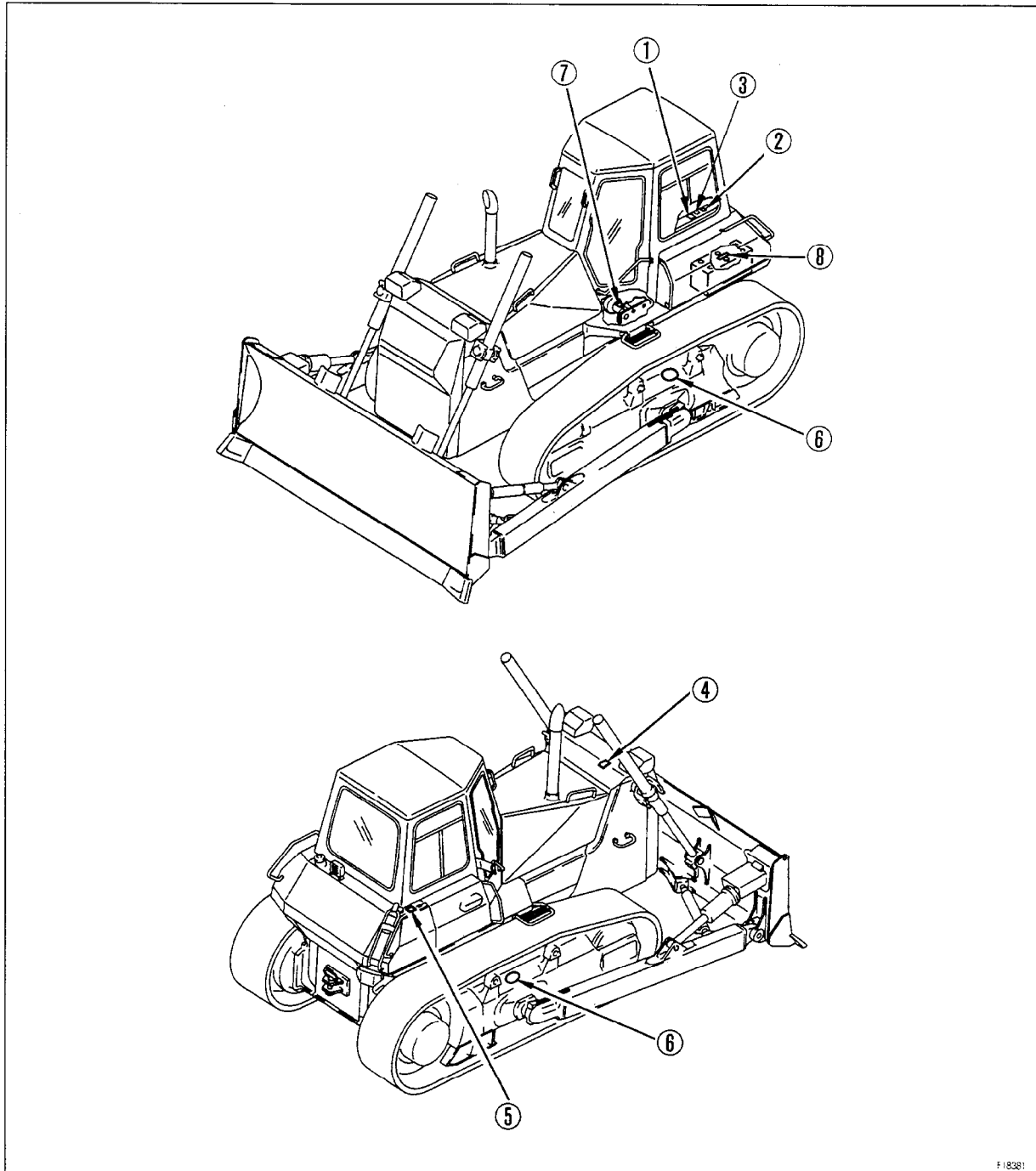

1. Warnings before operating machine
(14X-98-11580)

⚠ WARNING

Improper operation and maintenance can cause serious injury or death.

Read manual and labels before operation and maintenance.
Follow instructions and warnings in manual and in labels on machine.

Keep manual in machine cab near operator.
Contact komatsu distributor for a replacement manual.

14X-98-11580

3. Warnings for leaving operator's seat
(14X-98-11541)

⚠ WARNING

To avoid hitting unlocked operation levers, before standing up from operator's seat, do the following:

- Move steering and directional lever neutral and move SAFETY LOCK LEVER (located left of seat) to LOCK position.
- Lower equipment to ground and move SAFETY LOCK LEVER (located right of seat) to LOCK position.

Sudden and unwanted machine movement can cause serious injury or death.

14X-98-11541

2. Warnings before moving in reverse
(14X-98-11590)

⚠ WARNING

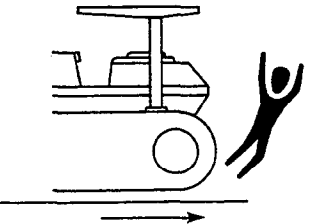

Before moving machine or its attachments:

- Honk horn to alert people nearby.
- Be sure no one is on machine area.
- Use spotter if necessary, particularly if you are moving in reverse.

Follow above even if equipped with back-up alarm and mirrors.

14X-98-11590

4. Warnings for hot water hazard
(14X-98-11531)

⚠ WARNING

Hot water hazard.

To prevent hot water from spurting out:

- Turn engine off.
- Allow water to cool.
- Slowly loosen cap to relieve pressure before removing.

14X-98-11531

9. POSITION FOR ATTACHING SAFETY LABELS

5. Warnings for hot oil hazard
(14X-98-11521)

WARNING

Hot oil hazard.

To prevent hot oil from spurting out:

- Turn engine off.
- Allow oil to cool.
- Slowly loosen cap to relieve pressure before removing.

14X-98-11521

6. Warnings for adjusting track tension
(14X-98-11551)

WARNING

High pressure hazard at track adjuster.

When adjusting track tension, never open plug more than one turn.
Turning further could cause injury from flying plug and grease.

See manual for adjustment instructions.

14X-98-11551

7. Warning for handling accumulator
(14X-98-11390)

WARNING Explosion hazard

- Keep away from frame
- Do not weld or drill

14X-98-11390

8. Warning for handling battery
(14X-98-11370)

WARNING

EXPLOSIVE GASES

- Cigarettes, flames or sparks could cause battery to explode.
- Always shield eyes and face from battery.
- Do not charge or use booster cables or adjust post connections without proper instruction and training.
- Keep vent caps tight and level.

POISON CAUSES SEVERE BURNS
Contains sulfuric acid.

- Avoid contact with skin, eyes or clothing.
- In event of accident flush with water and call a physician immediately.
- Keep out of reach of children.

14X-98-11370

9. Warning for ROPS.
(09620-30202)

KOMATSU

ROLL-OVER PROTECTIVE STRUCTURE(ROPS) CERTIFICATION

THIS KOMATSU ROPS, MODEL & TYPE No. [] SERIAL No. [] WHEN INSTALLED IN ACCORDANCE WITH THE MANUFACTURERS INSTALLATION INSTRUCTIONS ON A [] FOR MAXIMUM PRIME MOVER MASS NOT GREATER THAN [] LBS/(kg), IS CERTIFIED TO COMPLY WITH THE FOLLOWING REQUIREMENTS: a) OSHA 29CFR. 1926. 1001 b) ISO 3471 (ROPS) c) SAE J [] & SAE J []

WARNING

- Altering ROPS may weaken it. Consult Komatsu Distributor before altering.
- ROPS may provide less protection if it has been structurally damaged or involved in roll-over.
- Always wear seat belt when moving.

Komatsu Ltd. Japan 2-3-6 Akasaka, Minato-ku, Tokyo, Japan 09620-30202

OPERATION



10. GENERAL VIEW

10.1 GENERAL VIEW OF MACHINE

If directions are indicated in this section, they refer to the directions shown by the arrows in the diagram below.

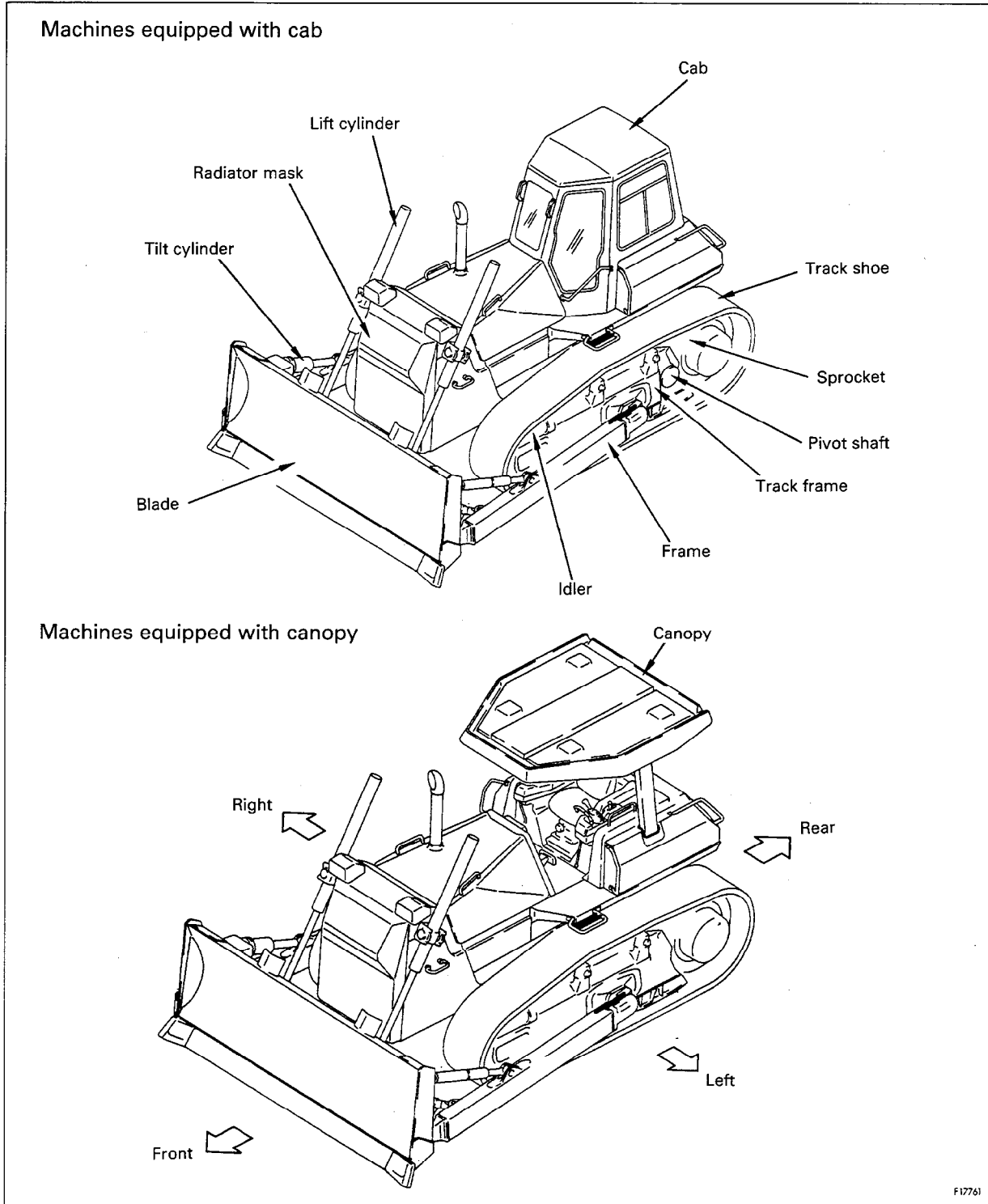

10.2 GENERAL VIEW OF CONTROLS AND GAUGES

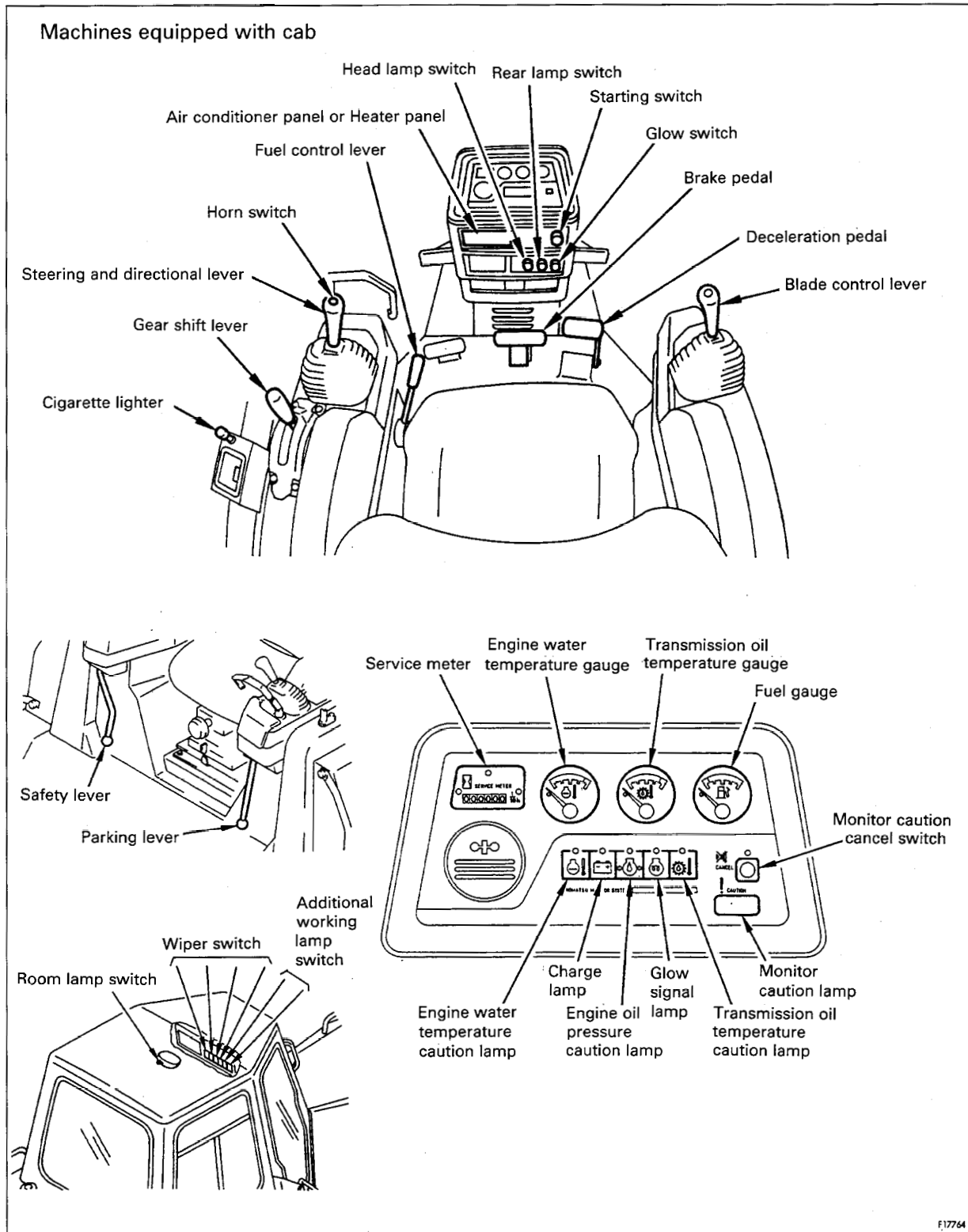

Machines equipped with canopy
Monitor panel specificaion

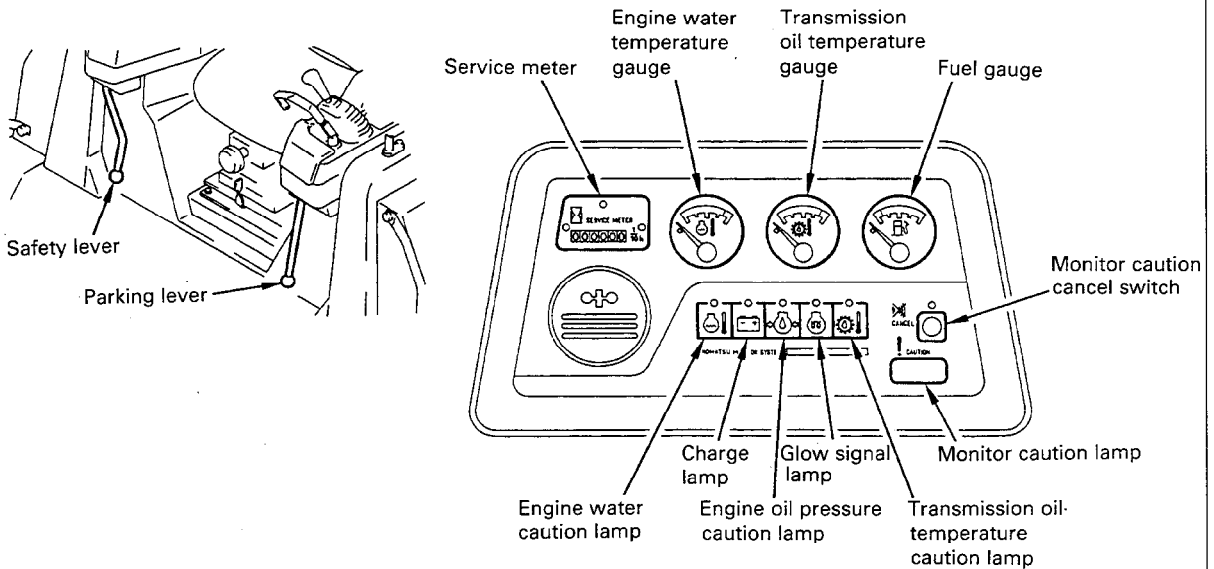
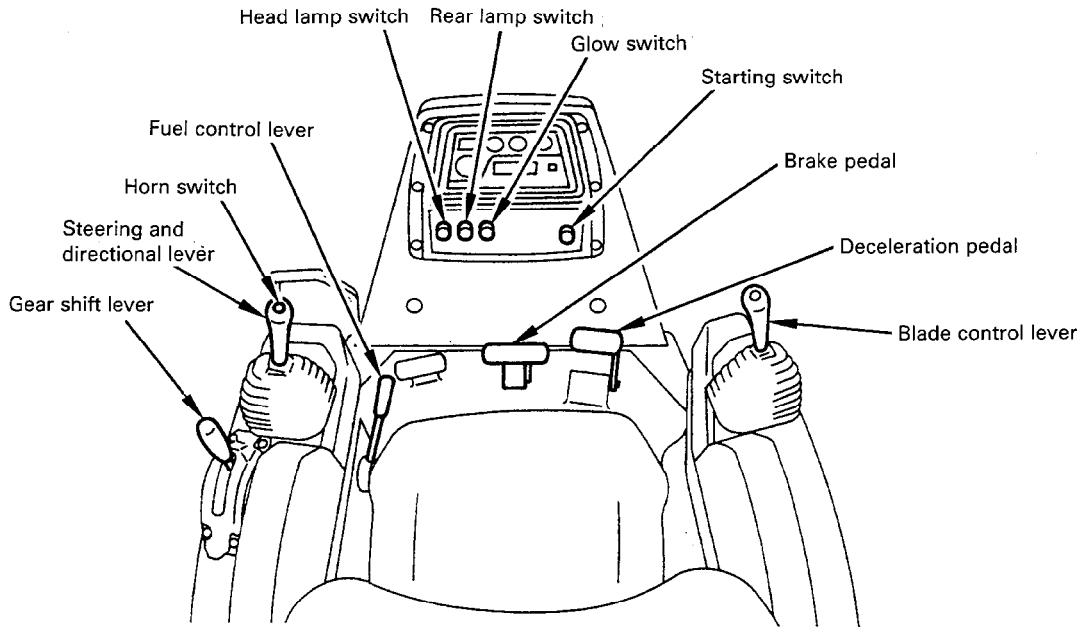

Machines equipped with canopy
Gauge panel specification

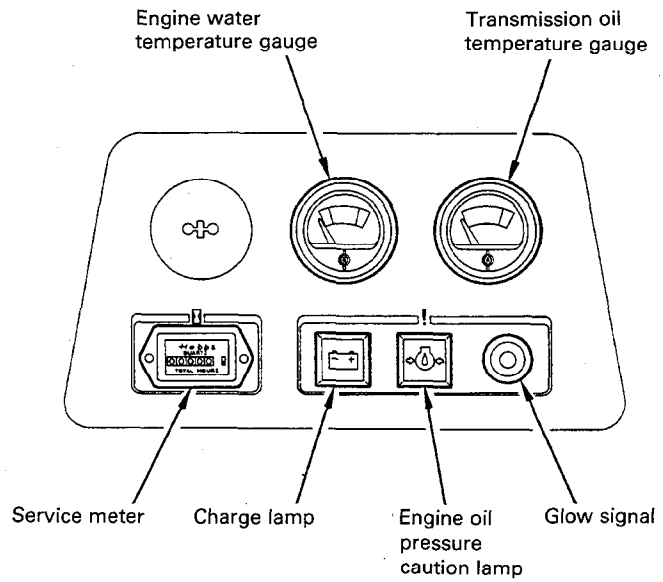
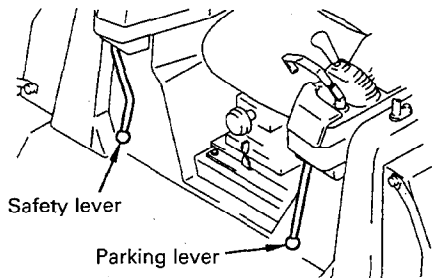
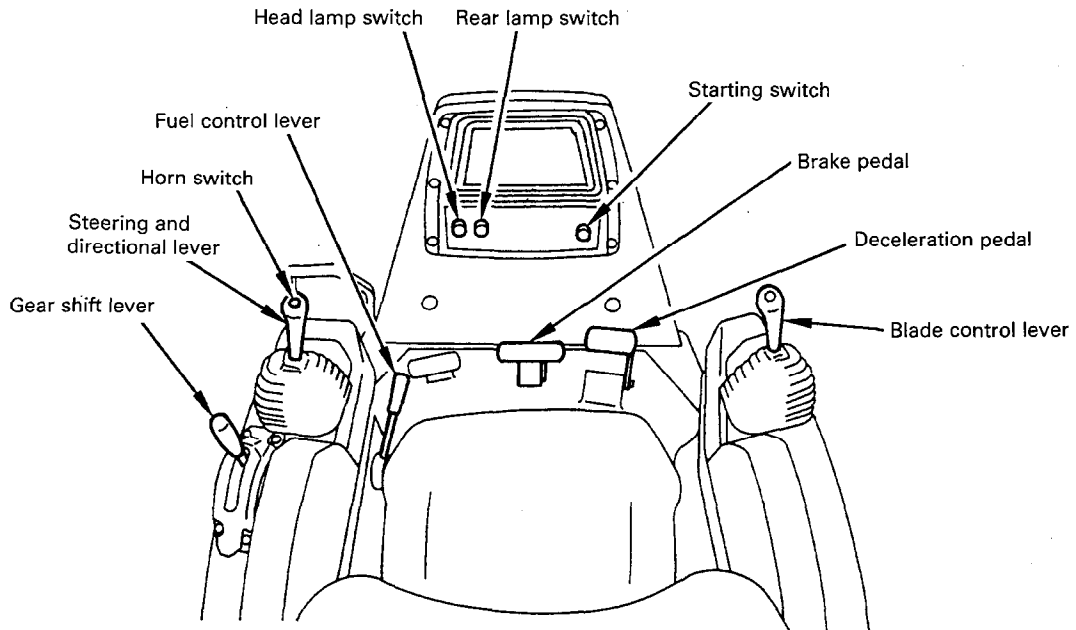

F17765

11. EXPLANATION OF COMPONENTS

The following is an explanation of the devices needed for operating the machine.

To carry out suitable operations correctly and safely, it is important to understand fully the methods of operating the equipment and the meanings of the displays.

Before reading the explanation of components, please read the table below to check what equipment is installed to your machine.

Equipment	Section No.	D65E-12 D65P-12		D65EX-12 D65PX-12	
		Canopy	Cab	Canopy	Cab
Front panel					
Monitor panel	11.1.1	o	o	o	o
Gauge panel	11.1.2	o	—	o	—
Air conditioner panel	11.1.3	—	o	—	o
Heater panel	11.1.4	—	o	—	o
Switch panel (cab)	11.1.5	—	o	—	o
Switch panel (canopy)	11.1.6	o	—	o	—
Switches					
Horn switch	11.2 1	o	o	o	o
Room lamp switch	11.2 2	—	o	—	o
Cigarette lighter	11.2 3	—	o	—	o
Wiper switch	11.2 4	—	o	—	o
Additional working lamp switch	11.2 5	—	o	—	o
Control levers and pedals					
Fuel control lever	11.3 1	o	o	o	o
Steering and directional lever	11.3 2	o	o	—	—
Steering and directional lever (with counterrotation turn)	11.3 2	—	—	o	o
Gear shift lever	11.3 3	o	o	o	o
Brake pedal	11.3 4	o	o	o	o
Deceleration pedal	11.3 5	o	o	o	o
Parking lever	11.3 6	o	o	o	o
Safety lever (For blade control lever)	11.3 7	o	o	o	o
Blade control lever	11.3 8				
Power tilt dozer		o	o	o	o
Power tilt, power pitch dozer		o	o	o	o
Angle dozer		o	o	o	o

11.1 FRONT PANEL (METERS, LAMPS, SWITCHES)

11.1.1 MONITOR PANEL (MONITOR PANEL SPECIFICATION)

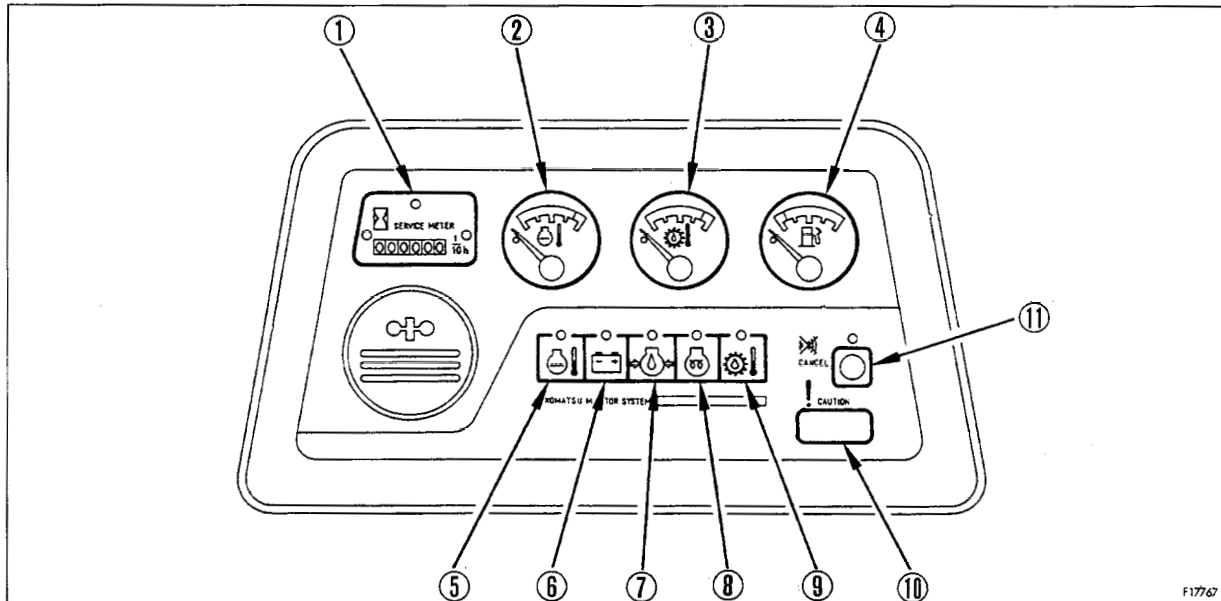

1. SERVICE METER

This meter shows the total operation hours of the machine. The service meter advances while the engine is running – even if the machine is not traveling.

Set the periodic maintenance intervals using this display.

When the engine is running, the green pilot lamp ① at the top of the meters flashes to indicate that the meter is advancing.

Meter ② will advance by 1 for each hour of operation regardless of the engine speed.

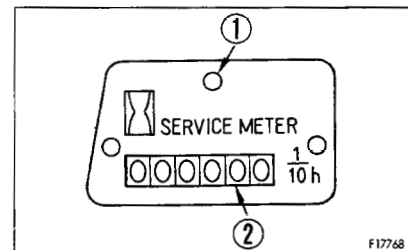

2. ENGINE WATER TEMPERATURE GAUGE

This gauge indicates the cooling water temperature.

When the indicator is in the white range during operation, the water temperature is normal.

If the indicator moves from the white range into the red range during operation, stop the machine immediately, run the engine under no load at a midrange speed, and wait for the indicator to go down to the white range.

After starting the engine, warm up it until the indicator moves into the white range.

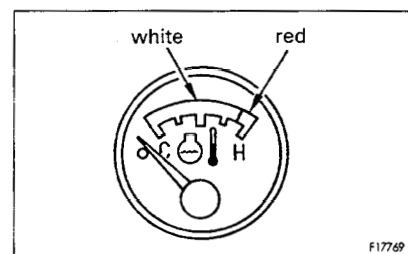

3. TRANSMISSION OIL TEMPERATURE GAUGE

This indicates the temperature of the transmission lubricating oil.

When the indicator is in the white range during operation, the oil temperature is normal.

If the indicator moves from the white range into the red range during operation, stop the machine, run the engine under no load at a midrange speed, and wait for the indicator to go down to the white range.

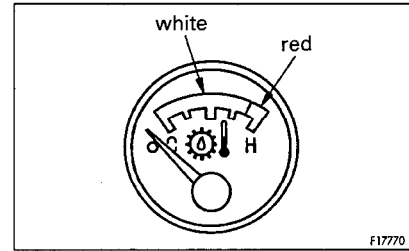

4. FUEL GAUGE

When the starting switch is turned ON, this gauge indicates the amount of fuel in the fuel tank.

F indicates that the tank is full.

E indicates that there is less than 43 liters of fuel remaining in the tank, so add fuel.

After each operation, be sure to fill up the fuel tank.

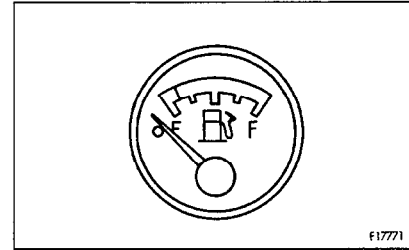

5. ENGINE WATER TEMPERATURE CAUTION LAMP

This warns of a rise in the temperature of the engine cooling water.

If the lamp lights up, stop the machine, run the engine under no load at a midrange speed, and wait for the indicator of the engine water temperature gauge to go down to the white range.

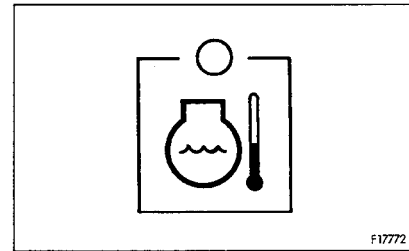

6. CHARGE LAMP

This lamp indicates malfunction of the alternator.

When the starting switch is turned ON, it will light up, but it should go out when the engine speed rises.

If the lamp lights up during operation, stop the engine and check the V-belt tension. If any abnormality is found, see "16. TROUBLESHOOTING".

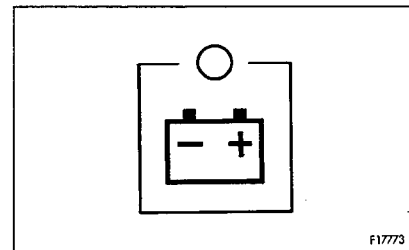

7. ENGINE OIL PRESSURE CAUTION LAMP

This lamp warns that the engine lubricating oil pressure has dropped. When the starting switch is turned ON, it will light up.

When the lamp goes off after the engine is started, the oil pressure is normal.

When the lamp lights up during operation, the oil pressure is lower.

Immediately stop the engine and look for the cause. For details, see "16. TROUBLESHOOTING".

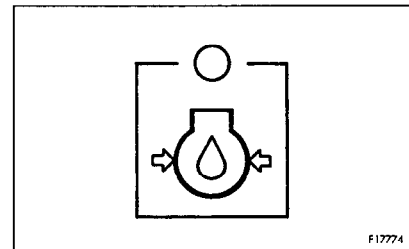

8. GLOW SIGNAL LAMP

This indicates the electrical intake air heater is red-heated.

While preheating is being carried out with the glow switch, the lamp lights up.

In the case of automatic preheating, the lamp goes out when the preheating is completed.

In the case of manual preheating, the lamp goes out when the glow switch is released.

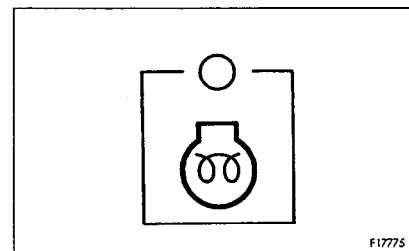

9. TRANSMISSION OIL TEMPERATURE CAUTION LAMP

This warns of a rise in the temperature of the oil at the transmission outlet port.

If the lamp lights up, stop the machine, run the engine under no load at a midrange speed, and wait for the indicator of the transmission oil temperature gauge to go down to the white range.

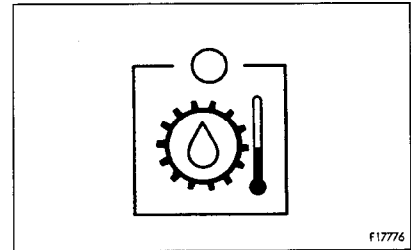
**10. MONITOR CAUTION LAMP**

This lamp lights up if any of caution lamps ⑤, ⑥, ⑦, or ⑨ light up. At the same time the alarm buzzer sounds.

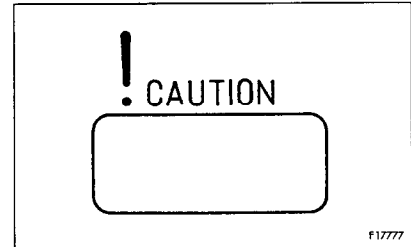
**11. MONITOR CAUTION CANCEL SWITCH**

This switch is used to cancel monitor caution lamp ⑩. Press the switch to turn the monitor caution lamp out and to stop the alarm buzzer.

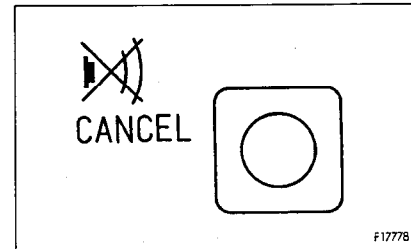

11.1.2 GAUGE PANEL (GAUGE PANEL SPECIFICATION)

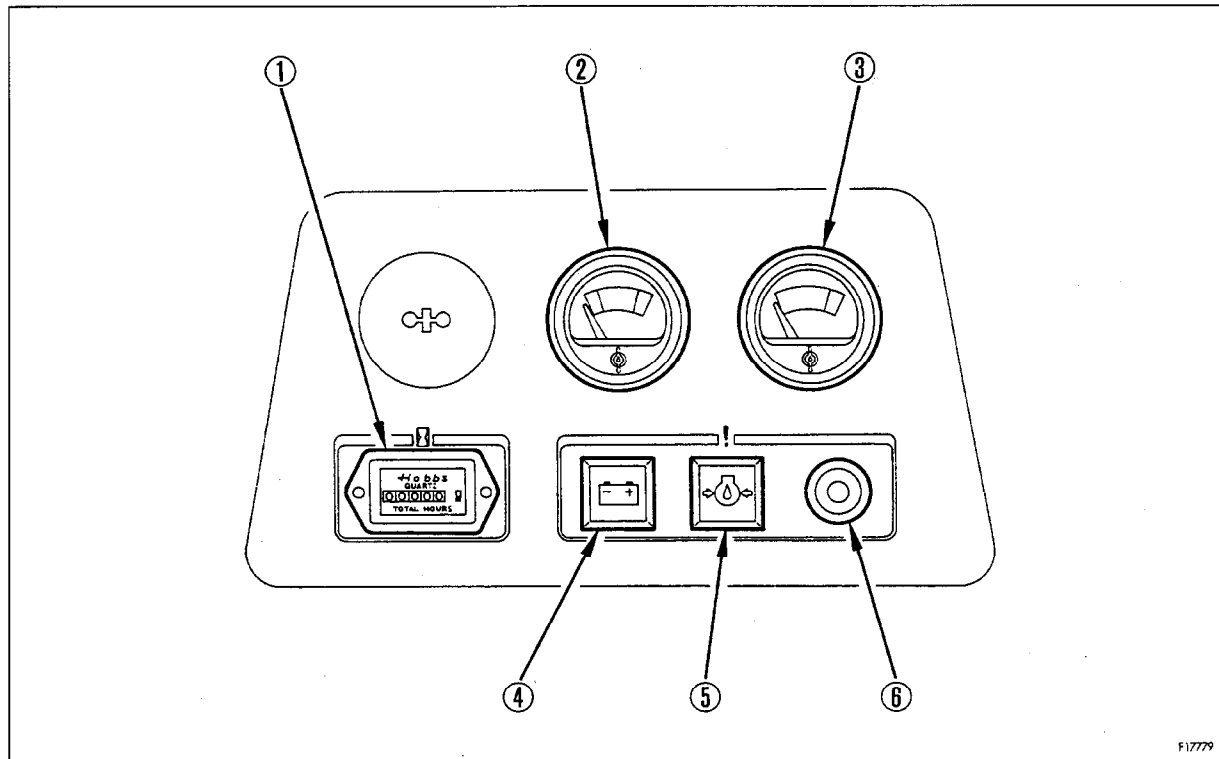

1. SERVICE METER

This meter shows the total operation hours of the machine. The service meter advances while the engine is running — even if the machine is not traveling. Set the periodic maintenance intervals using this display. Meter will advance by 1 for each hour of operation regardless of the engine speed.

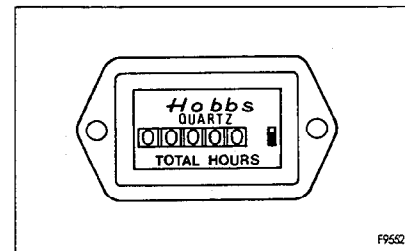

2. ENGINE WATER TEMPERATURE GAUGE

This gauge indicates the cooling water temperature.

When the indicator is in the green range during operation, the water temperature is normal.

If the indicator moves from the green range into the red range during operation, stop the machine immediately, run the engine under no load at a midrange speed, and wait for the indicator to go down to the green range.

After starting the engine, warm up it until the indicator moves into the green range.

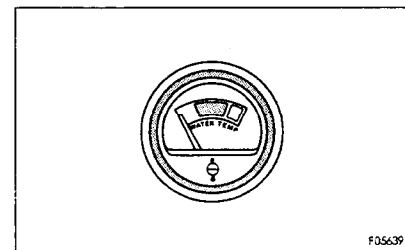

3. TRANSMISSION OIL TEMPERATURE GAUGE

This indicates the temperature of the transmission lubricating oil.

When the indicator is in the green range during operation, the oil temperature is normal.

If the indicator moves from the green range into the red range during operation, stop the machine, run the engine under no load at a midrange speed, and wait for the indicator to go down to the green range.

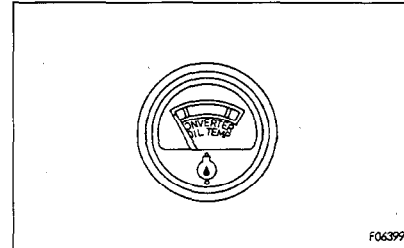

F06399

4. CHARGE LAMP

This lamp indicates malfunction of the alternator.

When the starting switch is turned ON, it will light up, but it should go out when the engine speed rises.

If the lamp lights up during operation, stop the engine and check the V-belt tension. If any abnormality is found, see "16. TROUBLESHOOTING".

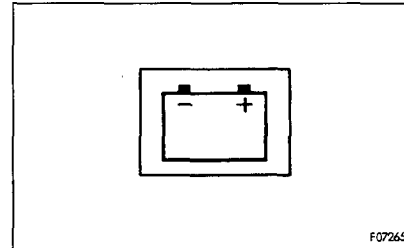

F07265

5. ENGINE OIL PRESSURE CAUTION LAMP

This lamp warns that the engine lubricating oil pressure has dropped. When the starting switch is turned ON, it will light up.

When the lamp goes off after the engine is started, the oil pressure is normal.

When the lamp lights up during operation, the oil pressure is lower.

Immediately stop the engine and look for the cause. For details, see "16. TROUBLESHOOTING".

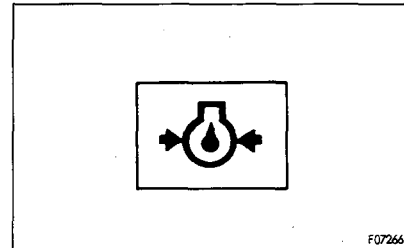

F07266

6. GLOW SIGNAL

This indicates the electrical intake air heater is red-heated.

When holding the starting switch key at the HEAT position, this signal glows red after 15 – 45 seconds.

When releasing the key, the key will return to the OFF position and the signal will go off.

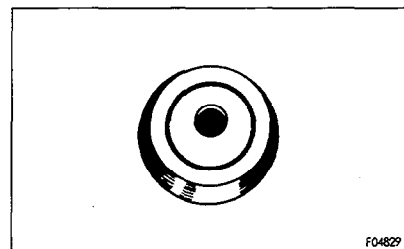

F04829

11.1.3 AIR CONDITIONER PANEL (MACHINES EQUIPPED WITH CAB, AIR CONDITIONER)

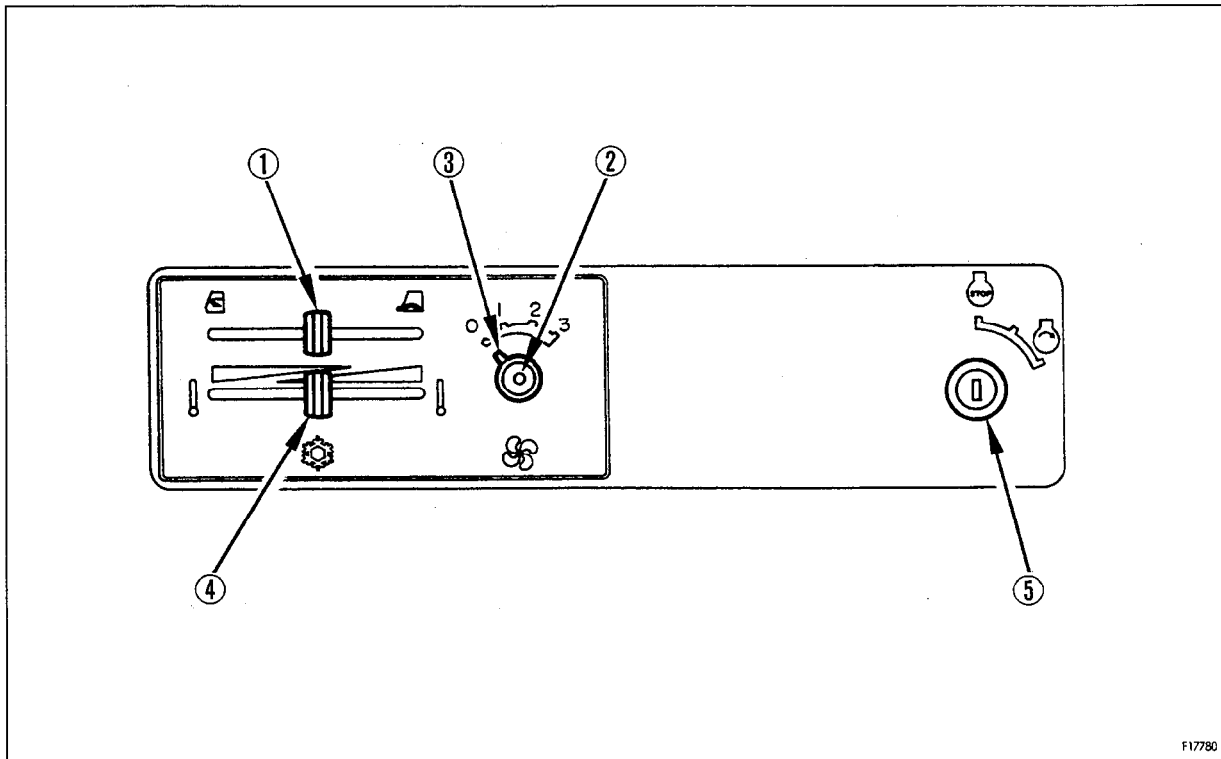

For details of handling switches ① to ④ below, see "11.16 HANDLING AIR CONDITIONER".

1. FRESH/RECIRC SELECTOR LEVER

This changes the air intake port used when cooling or heating.

- RECIRC () uses the air inside the cab.

Turn the switch normally to this position when strong cooling is needed. In this position, no ventilation or pressurizing is carried out.

- FRESH () takes in outside air.

This is the standard position for cooling and heating.

In this position, fresh air is brought in from outside to carry out ventilation. In addition, the inside of the cab is pressurized to prevent the entry of dust.

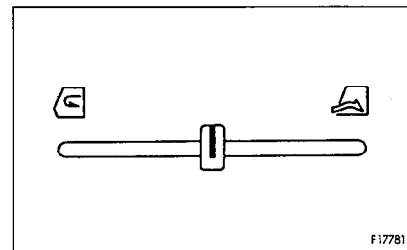

2. AIR CONDITION SWITCH

When the switch is pressed and the blue lamp lights up, the cooling function is actuated. Use this switch for cooling or dehumidifying.

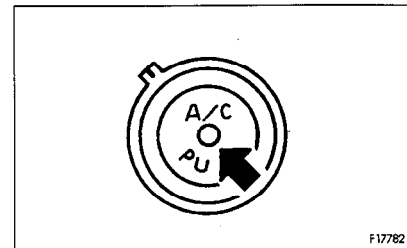

3. BLOWER SWITCH

This acts as the wind flow control switch and main switch when cooling or heating.

- The air flow can be set to three stages: 1 (LOW) → 2 (MEDIUM) → 3 (HIGH).
- If the switch is set to 0, the power is switched off and the air conditioner stops.

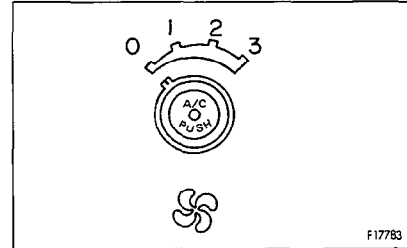

4. TEMPERATURE CONTROL LEVER

This is used to control the temperature for cooling or heating.

- When the temperature control lever is moved to the right, the temperature of the air coming from the vents becomes lower.
(The water valve is closed and the heating function is stopped.)
- When the temperature control lever is moved to the left, the temperature of the air coming from the vents becomes higher.
(The water valve is opened and the heating function is started.)

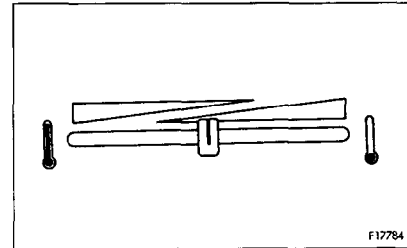

5. STARTING SWITCH

This switch is used to start the engine.

OFF () position:

At this position, the starting switch key can be inserted or removed. When the switch is turned to this position, the electrical circuits are switched off.

Do not the starting switch key at the OFF position while the engine is running.

ON position:

In this position, electric current flows in the charging and lamp circuits.

Keep the starting switch key at the ON position while the engine is running.

START () position:

This is the position to start the engine. Hold the key at this position while cranking. Release the key immediately after the engine has been started. The key will return to ON position when released.

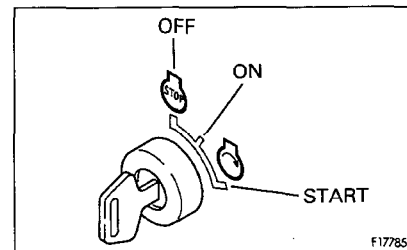

11.1.4 HEATER PANEL (MACHINES EQUIPPED WITH CAB, HEATER)

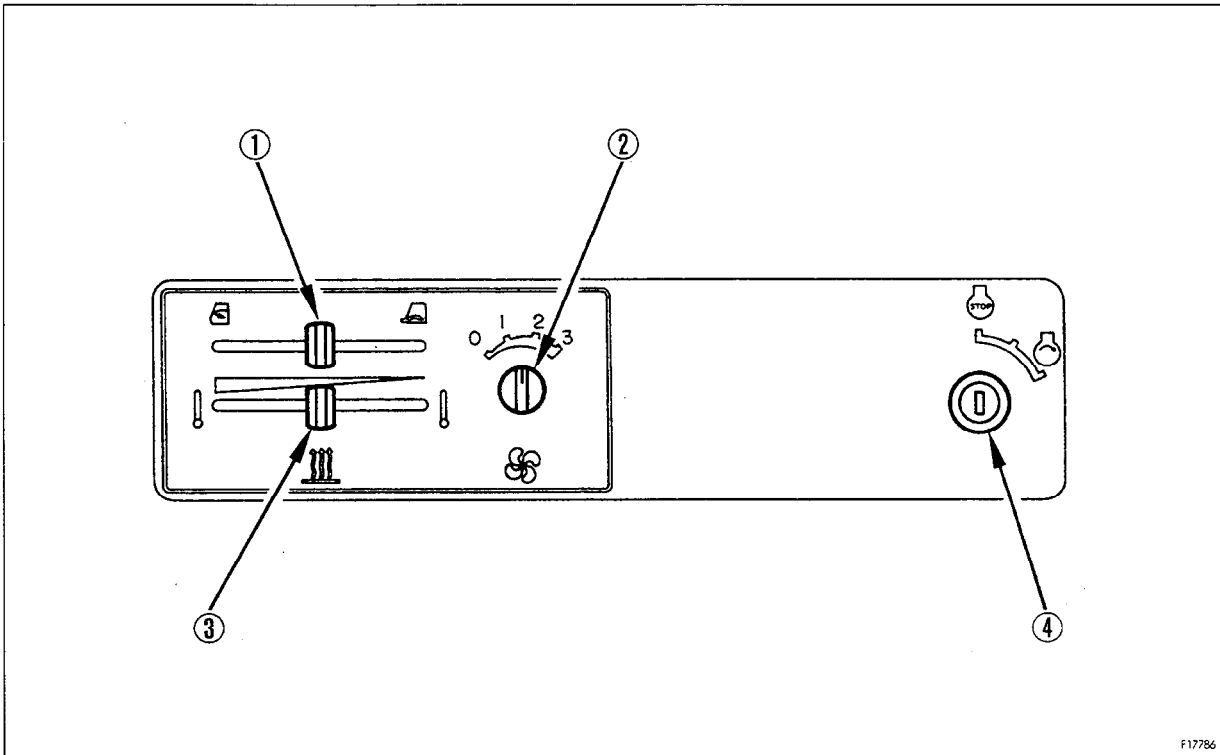

For details of handling switches ① to ③ below, see “11.17 HANDLING HEATER”.

1. FRESH/RECIRC SELECTOR LEVER

This changes the air intake port used when cooling or heating.

- RECIRC () uses the air inside the cab.

Turn the switch normally to this position when strong cooling is needed. In this position, no ventilation or pressurizing is carried out.

- FRESH () takes in outside air.

This is the standard position for cooling and heating.

In this position, fresh air is brought in from outside to carry out ventilation. In addition, the inside of the cab is pressurized to prevent the entry of dust.

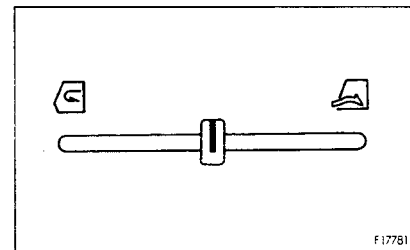

2. BLOWER SWITCH

This acts as the wind flow control switch and main switch when cooling or heating.

- The air flow can be set to three stages: 1 (LOW) → 2 (MEDIUM) → 3 (HIGH).
- If the switch is set to 0, the power is switched off and the heater stops.

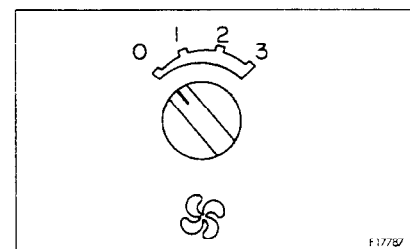

3. TEMPERATURE CONTROL LEVER

This is used to control the temperature for heating.

- When the temperature control lever is moved to the right, the temperature of the air coming from the vents becomes lower.
- When the temperature control lever is moved to the left, the temperature of the air coming from the vents becomes higher.

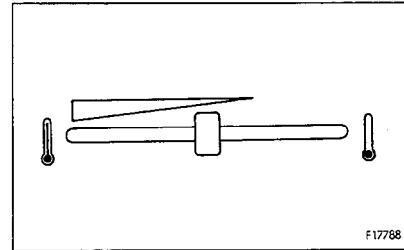

4. STARTING SWITCH

This switch is used to start the engine.

OFF (STOP) position:

At this position, the starting switch key can be inserted or removed. When the switch is turned to this position, the electrical circuits are switched off.

Do not the starting switch key at the OFF position while the engine is running.

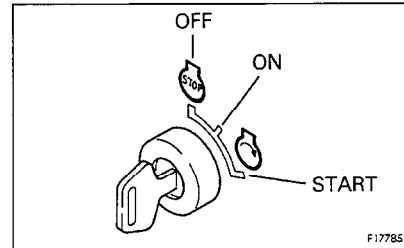

ON position:

In this position, electric current flows in the charging and lamp circuits.

Keep the starting switch key at the ON position while the engine is running.

START (START) position:

This is the position to start the engine. Hold the key at this position while cranking. Release the key immediately after the engine has been started. The key will return to ON position when released.

11.1.5 SWITCH PANEL (MACHINES EQUIPPED WITH CAB)

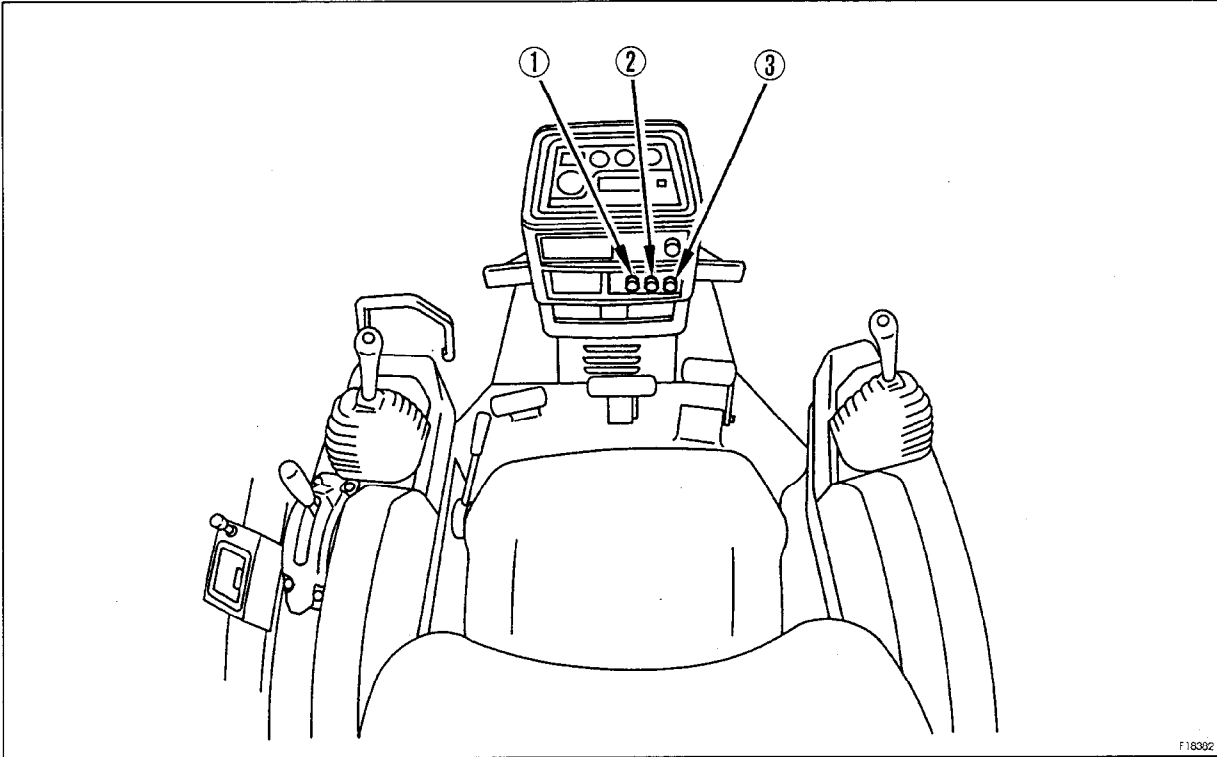

1. HEAD LAMP SWITCH

This lights up the head lamps.
OFF position: Lamps are out
ON position: Lamps light up

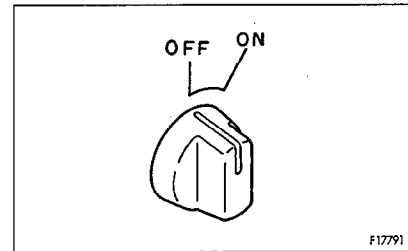

2. REAR LAMP SWITCH

This lights up the rear lamps.
OFF position: Lamps are out
ON position: Lamps light up

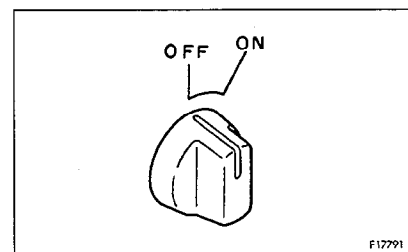

3. GLOW SWITCH

This actuates the electrical heater to warm up the engine intake air.

OFF position: The preheating is not actuated.

AUTO position: AUTO preheating is actuated. The length of the preheating time varies according to the ambient temperature when the ambient temperature is below approx. -5°C .

I position: This is used when AUTO preheating is not enough to start the engine in cold weather simply with the glow switch at the AUTO position.

When the switch is released, it will return to the AUTO position.

II position: This is used when carrying out preheating manually without using AUTO preheating.

When the switch is released, it will return to the OFF position.

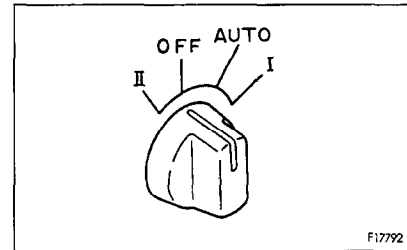

F17792

11.1.6 SWITCH PANEL (MACHINES EQUIPPED WITH CANOPY)

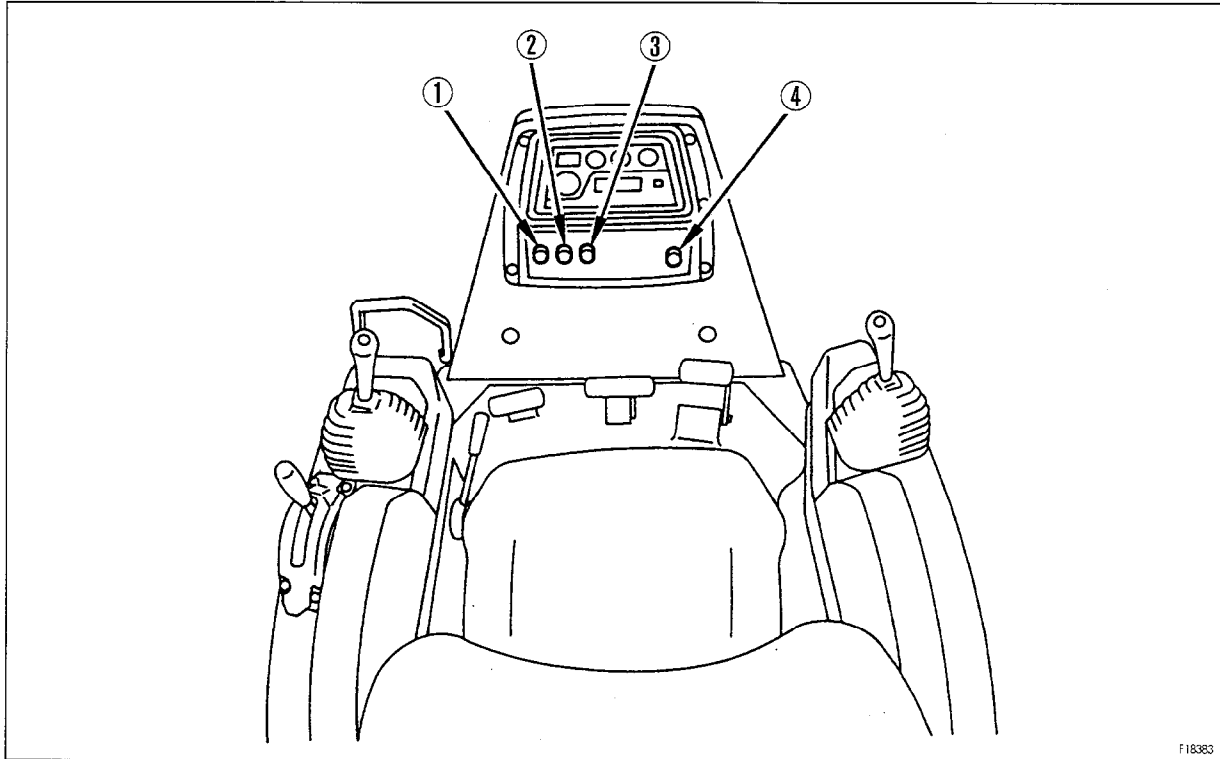

F18383

1. HEAD LAMP SWITCH

This lights up the head lamps.

OFF position: Lamps are out

ON position: Lamps light up

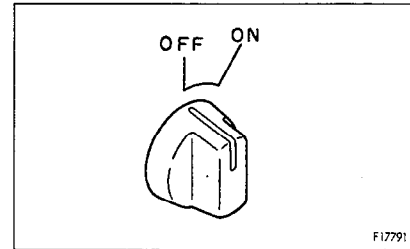

F17791

2. REAR LAMP SWITCH

This lights up the rear lamps.

OFF position: Lamps are out

ON position: Lamps light up

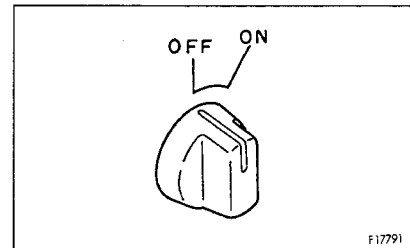

F17791

3. GLOW SWITCH (MONITOR PANEL SPECIFICATION)

This actuates the electrical heater to warm up the engine intake air.

OFF position: The preheating is not actuated.

AUTO position: AUTO preheating is actuated. The length of the preheating time varies according to the ambient temperature when the ambient temperature is below approx. -5°C .

I position: This is used when AUTO preheating is not enough to start the engine in cold weather simply with the glow switch at the AUTO position.

When the switch is released, it will return to the AUTO position.

II position: This is used when carrying out preheating manually without using AUTO preheating.

When the switch is released, it will return to the OFF position.

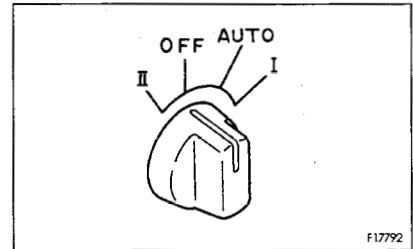

F17792

4. STARTING SWITCH

This switch is used to start the engine.

OFF (STOP) position:

At this position, the starting switch key can be inserted or removed. When the switch is turned to this position, the electrical circuits are switched off.

Do not the starting switch key at the OFF position while the engine is running.

ON position:

In this position, electric current flows in the charging and lamp circuits.

Keep the starting switch key at the ON position while the engine is running.

START (START) position:

This is the position to start the engine. Hold the key at this position while cranking. Release the key immediately after the engine has been started. The key will return to ON position when released.

HEAT (HEAT) position (Gauge panel specification):

Turn the starting switch key to the HEAT position when starting in cold weather.

If the key is held at the HEAT position, the electrical heater is heated and the glow signal lights up or glows red. If the glow signal flashes or glows red, release the key immediately.

When the key is released, it will return to OFF, so turn it immediately to the START position to start the engine.

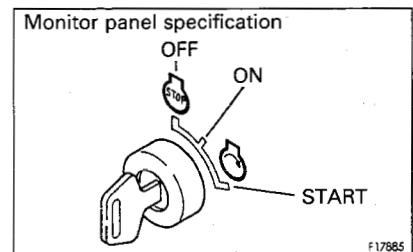

F17885

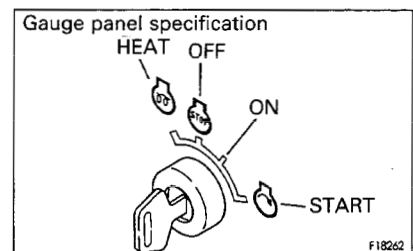

F18262

11.2 SWITCHES

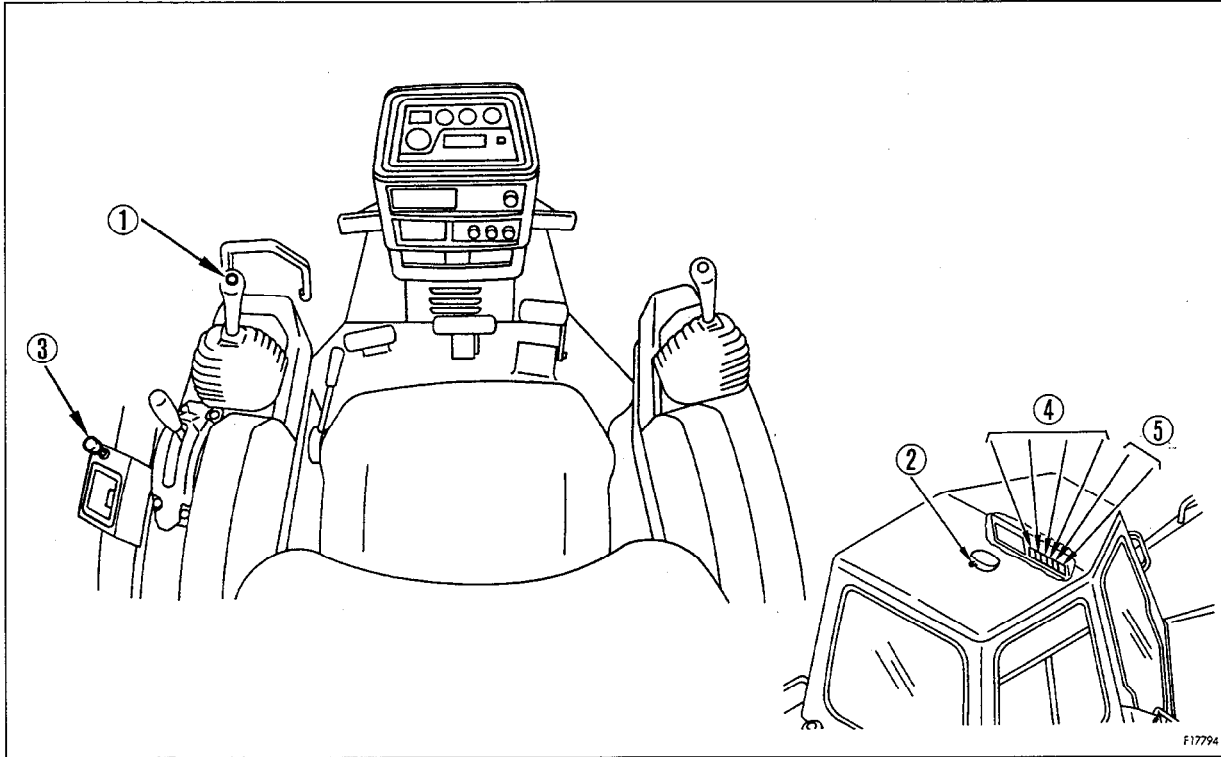

1. HORN BUTTON

Press the button in the middle of the steering and directional lever to sound the horn.

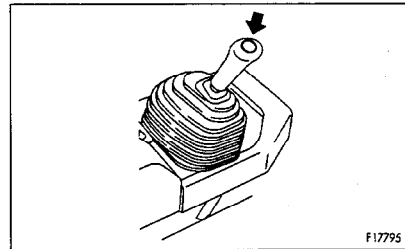

2. ROOM LAMP SWITCH (MACHINES EQUIPPED WITH CAB)

This lights up the room lamp.

ON position: Lamp lights up

OFF position: Lamp is out

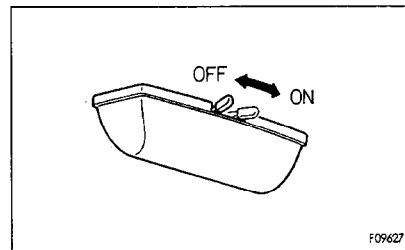

3. CIGARETTE LIGHTER (MACHINES EQUIPPED WITH CAB)

This is used to light cigarettes.

When the cigarette lighter is pushed in, it will return to its original position after a few seconds, so take it out to light your cigarette.

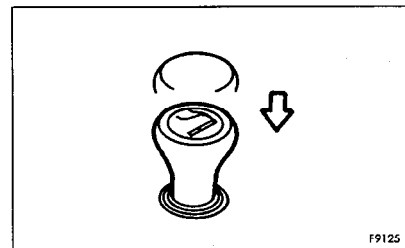

NOTICE

This cigarette lighter is 24V. Do not use it as the power source for 12 V equipment.

4. WIPER SWITCH (MACHINES EQUIPPED WITH CAB)

This activates the wipers.

The wiper switches are as follows.

- ① Left door
- ② Front window
- ③ Right door
- ④ Rear window

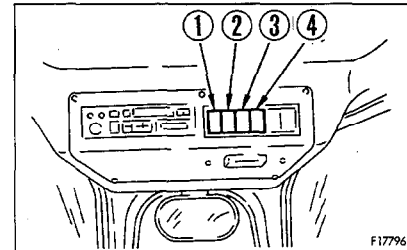

This is also used as the window washer switch.

The switch is operated as follows.

- Window washer only
Keep the switch pressed to the OFF position to spray out water.

- Wiper only
If this is switched on, the wiper will start.

- Wiper and window washer
If this is kept pressed to the ON position while the wiper is working, water will be sprayed out.

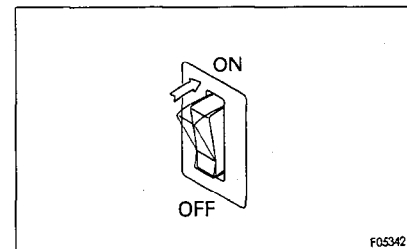
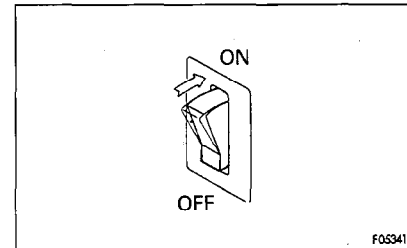
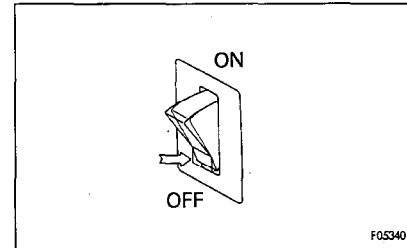

5. ADDITIONAL WORKING LAMP SWITCH (MACHINES EQUIPPED WITH CAB)

This is used to turn on the additional working lamp.

- ① Head lamp switch
- ② Rear lamp switch

Push in the direction of the arrow to turn on the lamps.

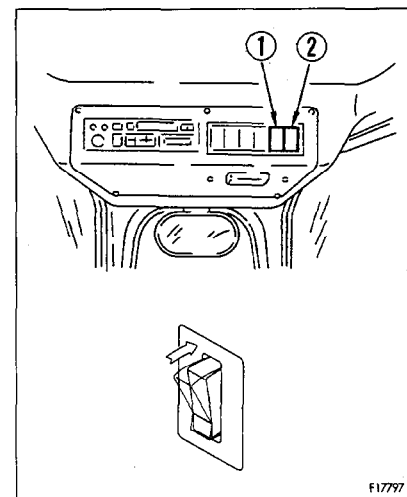

11.3 CONTROL LEVERS AND PEDALS

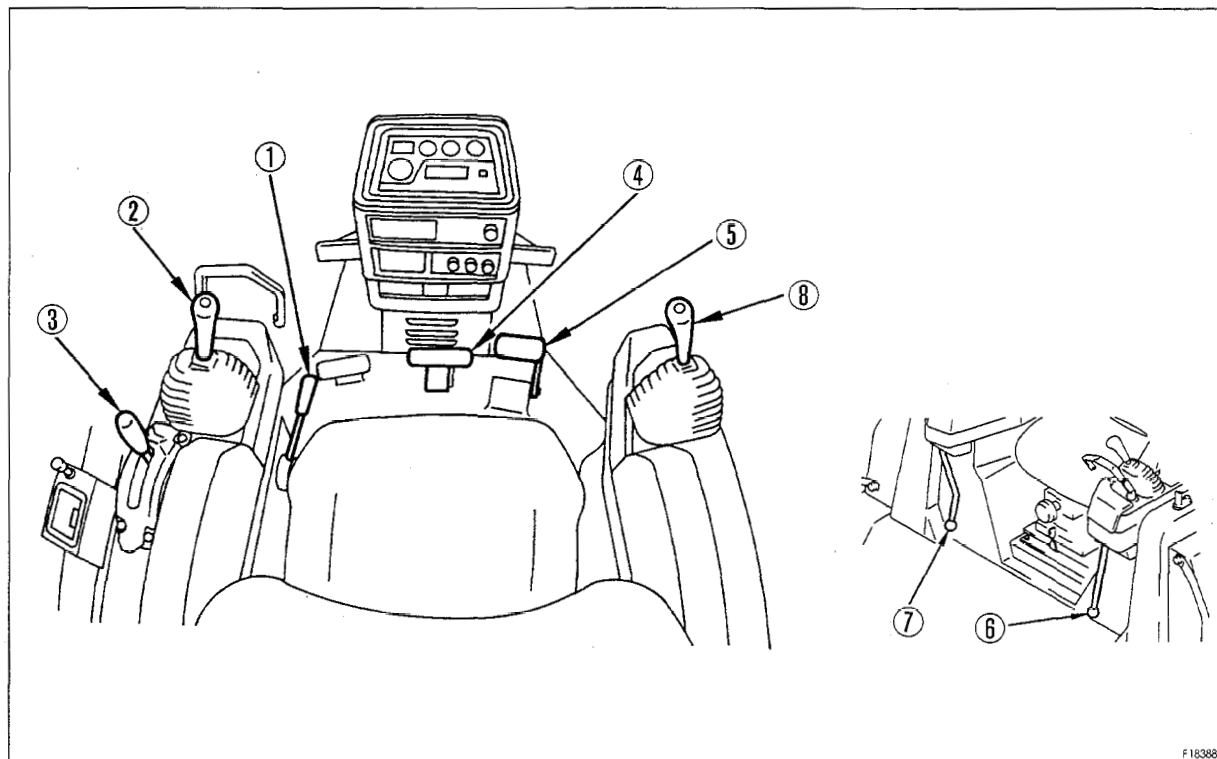

F18388

1. FUEL CONTROL LEVER

This lever is used to control the engine speed and output.

- ① Engine stop position: Push the lever forward fully.
- ② Low idling position: Pull the lever from engine stop position ① until you feel the operating force falls off.
- ③ High idling position: Pull the lever fully from low idling position.

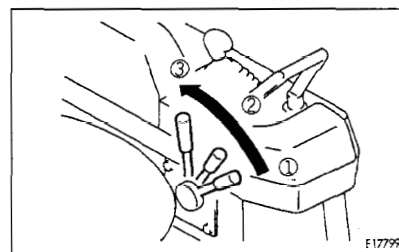

F17799

2. STEERING AND DIRECTIONAL LEVER (D65E, P)

This lever is used to switch between forward and reverse and to steer the machine.

Forward-reverse shifting

- ①: FORWARD
- ②: REVERSE
- Ⓝ: NEUTRAL

Push the lever forward, the machine will move off forward.

Pull the lever backward, the machine will move off in reverse.

Steering

- Ⓛ: LEFT TURN
- Ⓡ: RIGHT TURN

If the lever is operated to the forward or reverse position and is moved partially in the direction of turn, the steering clutch is disengaged and the machine turns gradually.

If the lever is moved more, the steering brake is applied and the machine will turn on the spot.

REMARK

If the lever is released when steering the machine, the lever will return to the ① position or the ② position and the machine will be returned to straight movement.

If you support the lever guide with your hand when steering, the turning operation will be easier.

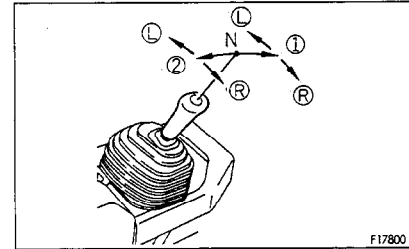

2. STEERING AND DIRECTIONAL LEVER (D65EX, PX)

This is used when shifting between forward and reverse, and when steering or carrying out counterrotation turns.

Forward-reverse shifting

- ①: FORWARD
- ②: REVERSE
- Ⓝ: NEUTRAL

Push the lever forward, the machine will move off forward.

Pull the lever backward, the machine will move off in reverse.

Steering

- Ⓛ: LEFT TURN
- Ⓡ: RIGHT TURN

If the lever is operated to the forward or reverse position and is moved partially in the direction of turn, the machine turns gradually.

If the lever is operated more in the direction of turn, the machine will turn more sharply.

REMARK

If the lever is released when steering the machine, the lever will return to the ① position or the ② position and the machine will be returned to straight movement.

If you support the lever guide with your hand when steering, the turning operation will be easier.

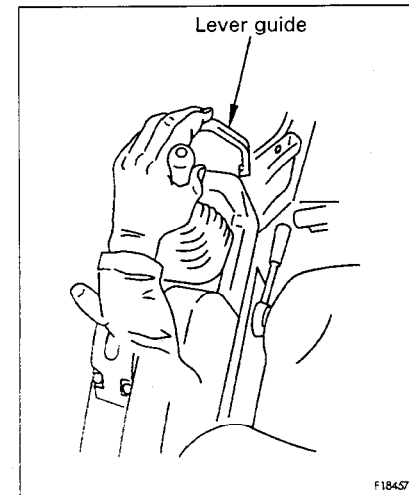
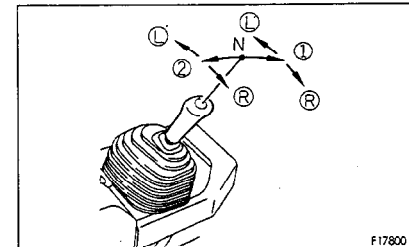

- Counterrotation turn

⚠ WARNING

- If the steering and directional lever is not operated fully to the forward or reverse position and the lever is operated to turn the machine, the machine may carry out a counterrotation turn, so do not try to turn the machine with the lever partially operated.
- When carrying out a counterrotation turn, if the load is not equal on the left and right sides, the machine may carry out a pivot turn, so check the ground conditions and be careful not to hit any obstacles.

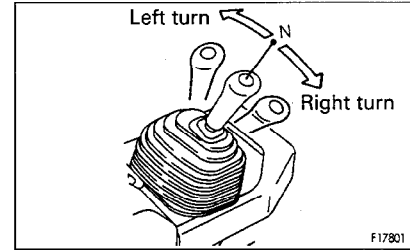

If the steering and directional lever is operated partially in the direction of turn with the lever at the N position, the left and right tracks will rotate in opposite directions and the machine will turn smoothly on the spot. If the steering lever is operated fully, the speed of the counterrotation turn will increase.

3. GEAR SHIFT LEVER

This lever changes the transmission gear range. There are three ranges, and the gear can be shifted simply by moving the gear shift lever to the desired position.

- ① First speed
- ② Second speed
- ③ Third speed

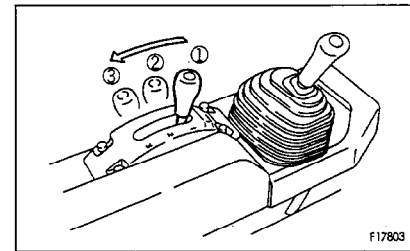

4. BRAKE PEDAL

⚠ WARNING

Do not place your foot on this pedal unnecessarily.

Depress the pedal to apply the right and left brakes.

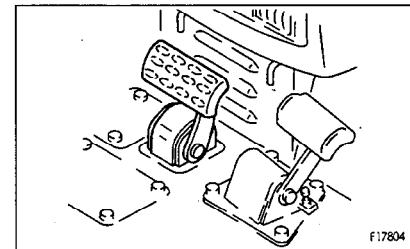

5. DECELERATION PEDAL

⚠ WARNING

- Do not place your foot on this pedal unnecessarily.
- When passing over the top of a hill or when a load is dumped over a cliff, the load is suddenly reduced, so there is danger that the travel speed will also increase suddenly. To prevent this, depress the decelerator pedal to reduce the travel speed.

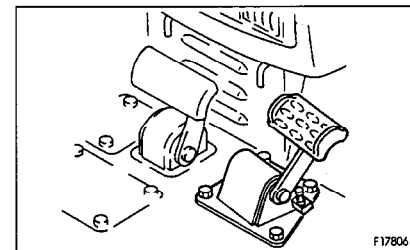

This pedal is used when reducing the engine speed. When switching between forward and reverse, or when stopping the machine, use this pedal to reduce speed.

6. PARKING LEVER

WARNING

When the machine is parked, always set the parking lever to the LOCK position.

This lever is used to apply the parking brake.

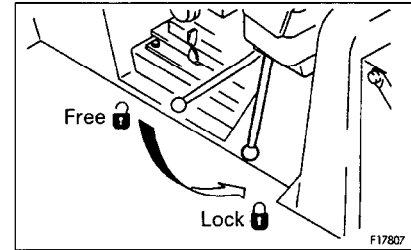

REMARK

If the parking lever is set to the LOCK position when the directional and steering lever is at the forward or reverse position, the directional and steering lever is automatically returned to the N position.

When starting the engine, check that the parking lever is at the LOCK position. If it is not at the LOCK position, the engine cannot be started.

7. SAFETY LEVER (For blade control lever)

WARNING

- When leaving the operator's compartment, set the safety lever securely to the LOCK position. If the control lever is not locked, and it is touched by mistake, this may lead to a serious accident.
- If the safety lever is not placed securely in the LOCK position, the control lever may not be properly locked. Check that the situation is as shown in the diagram.
- When parking or servicing the machine, be sure to lower the blade and set the safety lock in the LOCK position.

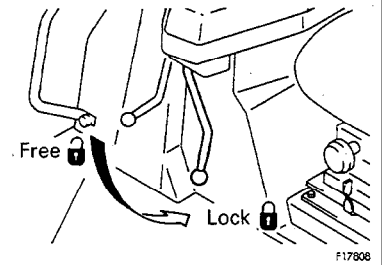

This is the locking device of blade control lever.

When the safety lever is set to the LOCK position, the TILT, LOWER, and FLOAT controls are locked.

If it is set to the LOCK position when the blade control lever is at the FLOAT position, the blade control lever is automatically returned to the HOLD position.

**8. BLADE CONTROL LEVER
(POWER TILDOZER)**

This lever is used to raise or tilt the blade.

Lifting control

① RAISE : ()

② HOLD : ()

Blade is stopped and held in this position.

③ LOWER : ()

④ FLOAT : ()

Blade will move freely according to external force.

REMARK

- When released from FLOAT position, this lever will not return to HOLD position, so it must be moved back by hand.
- When starting the engine, set the blade control lever to the HOLD position.
If it is at the FLOAT position, the engine will not start.

Tilting control

Ⓐ LEFT TILT : ()



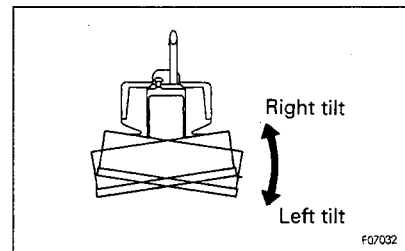
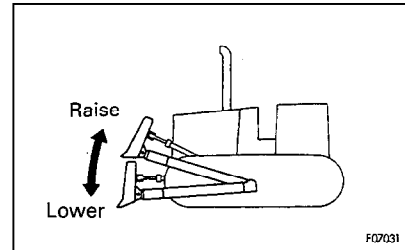
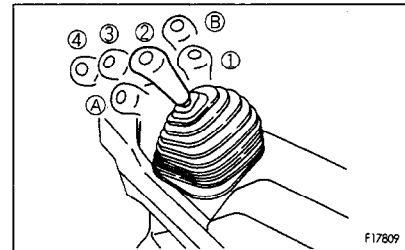

Ⓑ RIGHT TILT : ()



**8. BLADE CONTROL LEVER
(FOR POWER TILT, POWER PITCH DOZER)**

This carries out the blade lift, tilt, and pitch operations.



Lifting control

- ① RAISE : ()
- ② HOLD : ()
Blade is stopped and held in this position.
- ③ LOWER : ()
- ④ FLOAT : ()
Blade will move freely according to external force.

REMARK

- When released from FLOAT position, this lever will not return to HOLD position, so it must be moved back by hand.
- When starting the engine, set the blade control lever to the HOLD position.
If it is at the FLOAT position, the engine will not start.

Tilting control

- Ⓐ LEFT TILT : ()
- Ⓑ RIGHT TILT : ()

Pitch control

- Ⓐ Rear pitch: Small blade cutting angle
- Ⓑ Forward pitch: Large blade cutting angle

First set the lever to the neutral position, then keep switch ③ in the center of the knob pushed down and carry out the tilt operation to change the cutting angle of the blade.

Precautions when using pitch control

When operating the pitch, the cutting angle is shown by the gauge bar on the right pitch cylinder. When using the pitch operation, the tilt operation changes as follows.

Pitch condition	Tilt operation	Amount of tilt
Max. forward pitch	Only left tilt operation is possible	Max. 890 mm
Forward pitch	Both left and right tilt operations are possible	Compared with standard: LEFT tilt is LARGER RIGHT tilt is SMALLER
Standard pitch		445 mm (both left and right)
Rear pitch		Compared with standard: LEFT tilt is SMALLER RIGHT tilt is LARGER
Max. rear pitch	Only right tilt operation is possible	Max. 890 mm

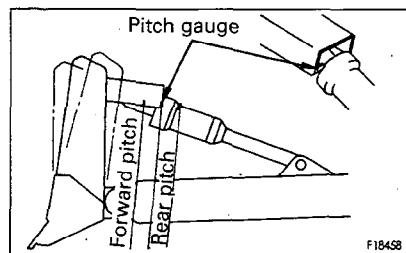
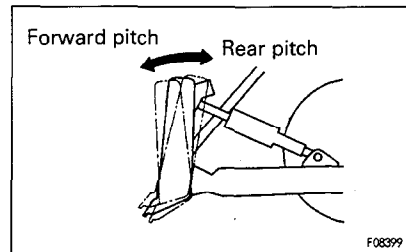
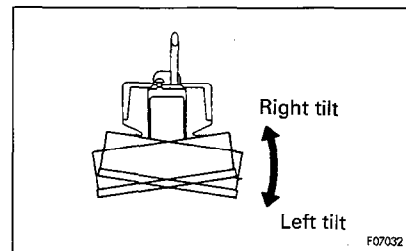
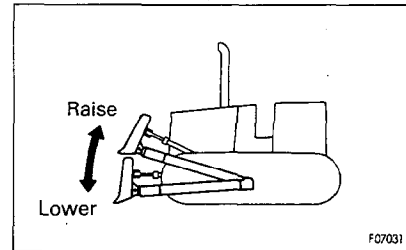
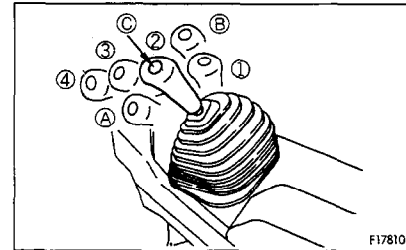

8. BLADE CONTROL LEVER (FOR ANGLEDOZER)

This lever is used to raise the blade.

Lifting control

① RAISE : ()

② HOLD : ()

Blade is stopped and held in this position.

③ LOWER : ()

④ FLOAT : ()

Blade will move freely according to external force.

REMARK

- When released from FLOAT position, this lever will not return to HOLD position, so it must be moved back by hand.
- When starting the engine, set the blade control lever to the HOLD position.

If it is at the FLOAT position, the engine will not start.

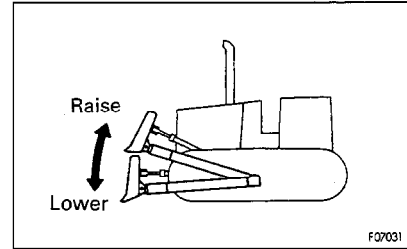
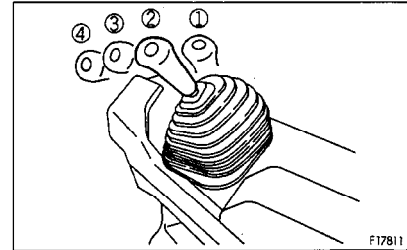

11.4 FUSE BOX

NOTICE

- Before replacing a fuse, be sure to turn off the starting switch.
- If the fuse blows again immediately after it is replaced, please contact your Komatsu distributor to have the system inspected.

The fuses protect the electrical equipment and wiring from burning out.

If the fuse becomes corroded, or white powder can be seen, or the fuse is loose in the fuse holder, replace the fuse.

Replace a fuse with another of the same capacity.

- Chassis
When the battery cover is opened, two fuse boxes can be found inside.
- Cab (machines equipped with cab)
It is installed at the bottom of the overhead panel.

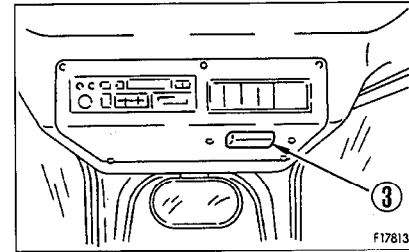
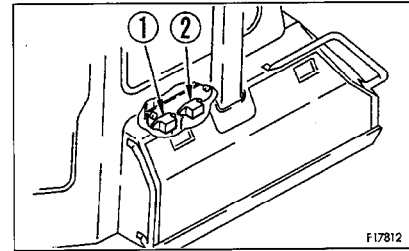

11.4.1 FUSE CAPACITY AND CIRCUIT NAME

Fuse box ①

No.	FUSE CAPACITY	CIRCUIT NAME
①	20A	Head lamp, Rear lamp
②	10A	Chassis power source
③	10A	Engine control system
④	10A	Horn
⑤	10A	Back-up alarm

Fuse box ①

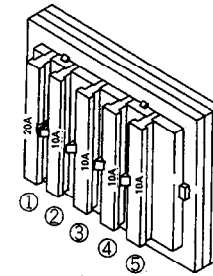

Fuse box ②

No.	FUSE CAPACITY	CIRCUIT NAME
①	10A	Cab radio
②	10A	Power pitch selector
③	20A	Air conditioner
④	—	—
⑤	10A	Chassis power source

Fuse box ②

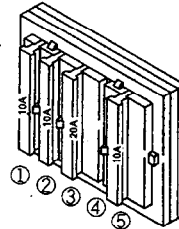

Fuse box ③ (machines equipped with cab)

No.	FUSE CAPACITY	CIRCUIT NAME
①	10A	Radio memory
②	20A	Radio, Lamps, Cigarette lighter
③	10A	Rear wiper
④	10A	Right door wiper
⑤	10A	Front wiper
⑥	10A	Left door wiper

Fuse box ③

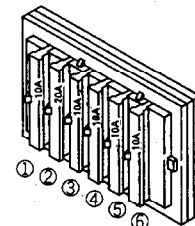

11.5 GREASE PUMP HOLDER

This is inside the left engine side cover.
Fit the grease pump to the holder when it is not being used.

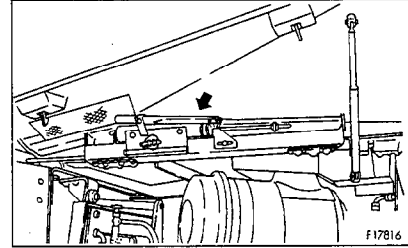

11.6 SHOVEL HOLDER

This can be used for storing a shovel with a rounded blade.

- Method of installing

1. Fix the shovel with stopper ① and holder ②.
2. Tighten with adjustment nut ③ so that the shovel does not move.

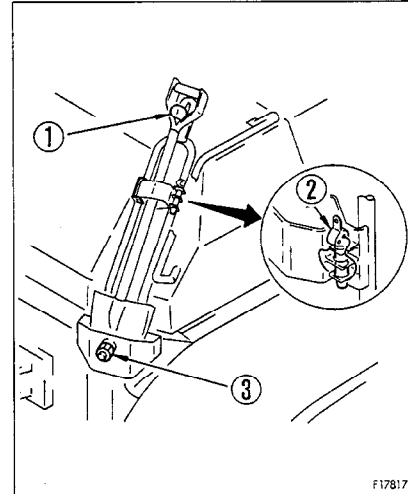

11.7 DOOR-OPEN LOCK (MACHINES EQUIPPED WITH CAB)

Use this when you want to keep the door held open.

1. Push the door against the door catch. The door will be held by the door catch.
2. To release the door, move lever ② inside the cab to the front of the cab. This will release the catch.

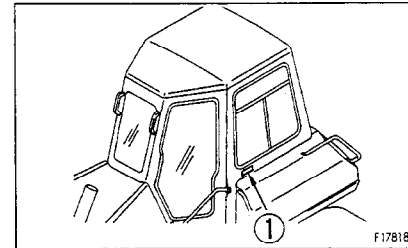

NOTICE

- When keeping the door open, fix it securely to the catch.
- Always close the door when traveling or carrying out operations. Leaving the door open will cause the door to break.
- Keep the door locked open securely.
The door may swing closed because of the vibration.

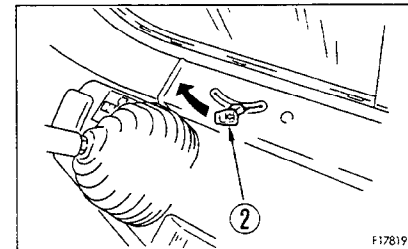

11.8 SASH GLASS INTERMEDIATE LOCK (MACHINES EQUIPPED WITH CAB)

WARNING

Do not stick your head or hand out of the window during operations.
Even when the glass is locked, it may move because of shock if the machine is started or stopped suddenly.

When carrying out operations with the cab sash glass open, use this block to prevent the glass from moving.

- When the lever is at the FREE position, the glass can be opened or closed.
- When the lever is moved to the LOCK (up or down) position, the glass is fixed in position.
- If the glass is not held securely, set the lever in the FREE position and rotate clockwise to strengthen the holding power.
- To reduce the holding power, turn counterclockwise.

NOTICE

Always close the window when traveling or carrying out operations. Leaving the window open will cause the window to break.

11.9 CAP WITH LOCK

Lock is installed to the fuel tank filler cap.

Open and close locking cap as follows:

- To open the cap
 1. Insert the starting switch key into the key hole on the cap. Insert the key as far as it will go. If the key is turned before it is inserted all the way to the shoulder, it may break.
 2. Turn the key clockwise, align the match mark on the cap with the rotor groove, then remove the cap.
- To lock the cap.
 1. Turn the cap into place.
 2. Turn the key counterclockwise and take the key out.

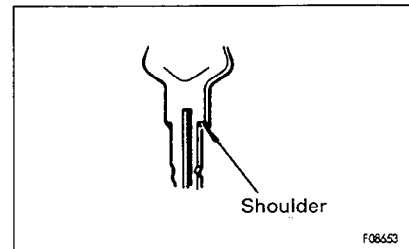
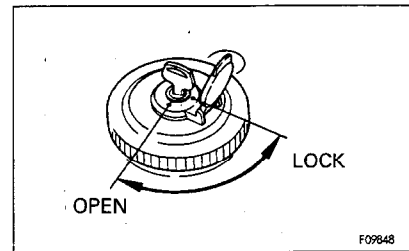
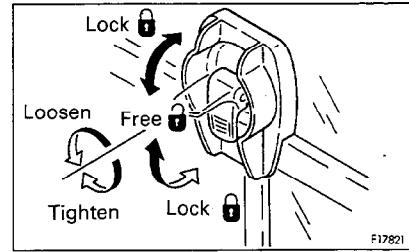
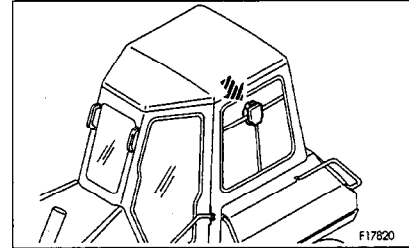

11.10 HOT AND COOL BOX (MACHINES EQUIPPED WITH CAB)

This is at the top of the front panel. It can be used to warm or cool three canned drinks.

This is interconnected with the air conditioner: During heating, it warms up the drinks; during cooling, it cools to the drinks.

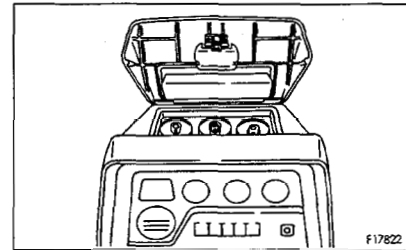

11.11 DOOR POCKET (MACHINES EQUIPPED WITH CAB)

These are on the inside of the left and right doors, and can be used for keeping things. However, do not put tools or other heavy objects in the pocket. If the pocket becomes dirty, turn three clips ①, remove the pocket and wash it.

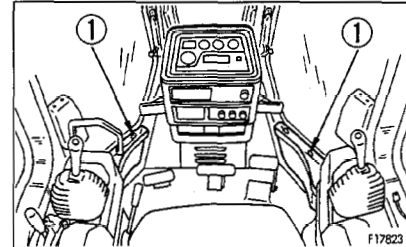

11.12 ASHTRAY (MACHINES EQUIPPED WITH CAB)

This is on the left side of the operator's seat.

Always make sure that you extinguish the cigarette before closing the lid.

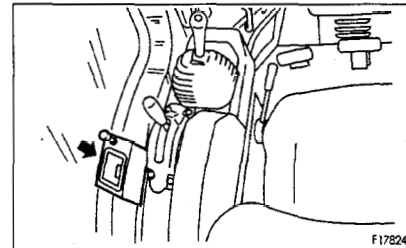

11.13 TOOL BOX

This is used for keeping the tools.

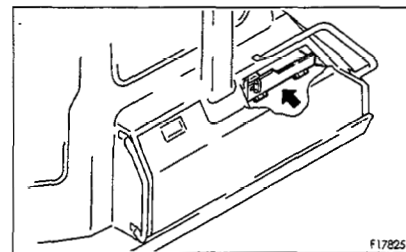

11.14 USING CAR RADIO (MACHINES EQUIPPED WITH CAB, CAR RADIO)

11.14.1 EXPLANATION OF PARTS

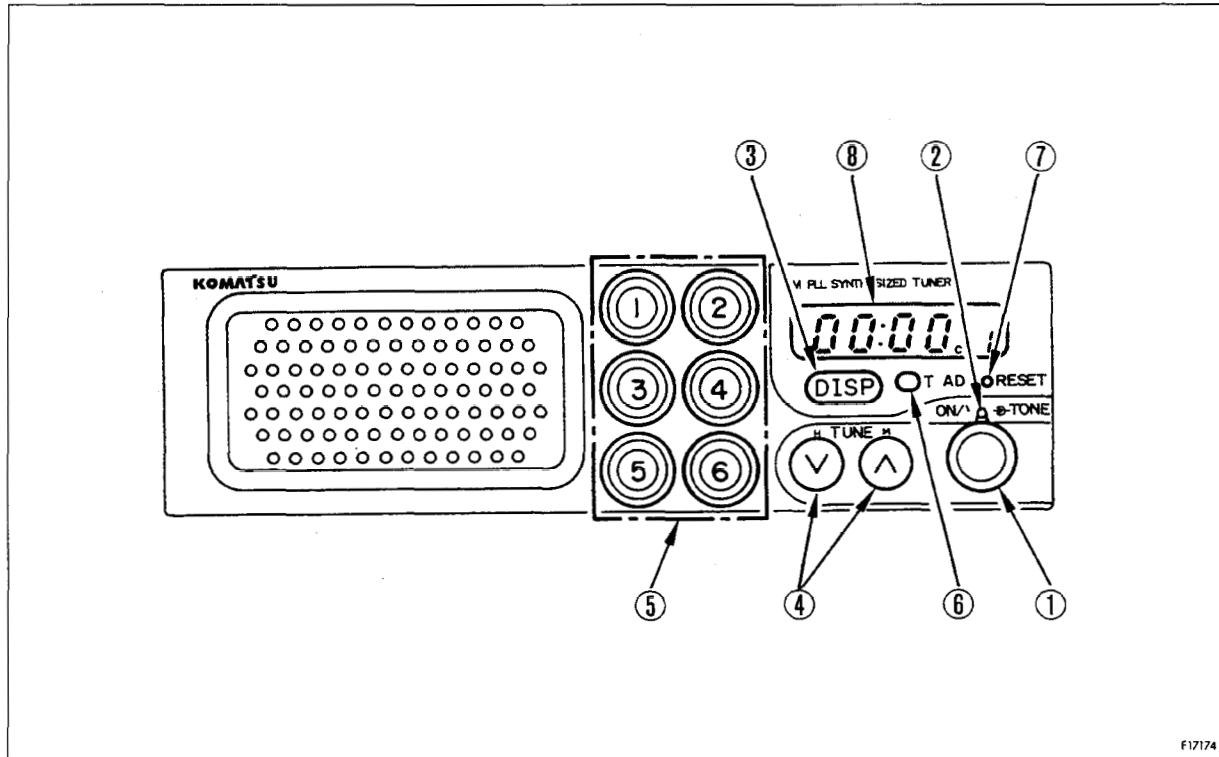

1. POWER SWITCH/VOLUME CONTROL KNOB (PUSH ON/VOL)

Push this knob to switch the radio on. The lighting in display area ① will light up and the frequency will be displayed. Press again to switch the power off.

Turn the knob clockwise to increase the sound, and counterclockwise to reduce it.

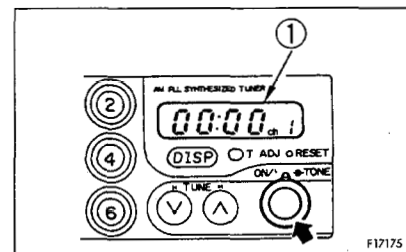

2. TONE CONTROL KNOB (TONE)

Turn this knob clockwise from the center position to emphasize the high sounds, and counterclockwise to emphasize the low sounds.

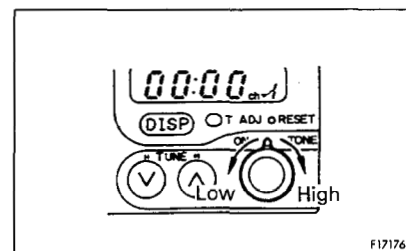

11. EXPLANATION OF COMPONENTS

3. DISPLAY BUTTON (DISP)

If the display button is pressed when the radio is being used, the frequency of the station being listened to is displayed for 5 seconds.

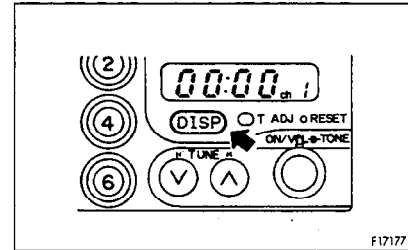

4. TUNING/HOUR, MIN ADJUSTMENT BUTTON (TUNE)

This is used to select the station or change the frequency.

If the station UP button ^ is pressed, the frequency will go up by 9 kHz each time it is pressed; if the station DOWN button V is pressed, the frequency will go down 9 kHz each time it is pressed.

If these buttons are kept pressed for more than 2 seconds, the station will be selected automatically.

When adjusting the time, these change the hour display and minute display.

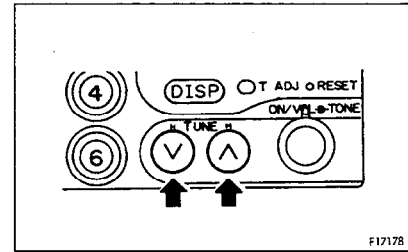

5. PRESET BUTTON (1, 2, 3, 4, 5, 6)

These buttons can be used to program the desired broadcasting stations. It is then possible to select the station at a touch.

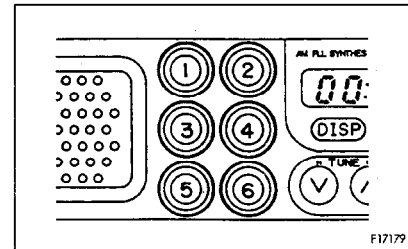

6. TIME ADJUSTMENT BUTTON (T.ADJ)

Press this button to adjust the time.

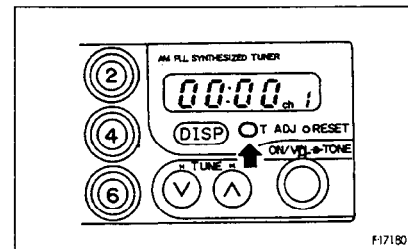

7. TIME RESET BUTTON (RESET)

Press this button to reset to the exact hour.

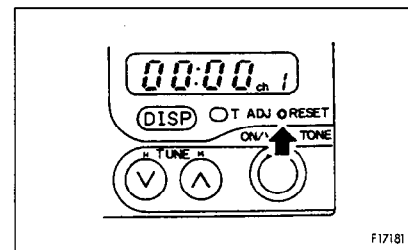

8. DISPLAY

This displays the frequency, time, and preset symbols.

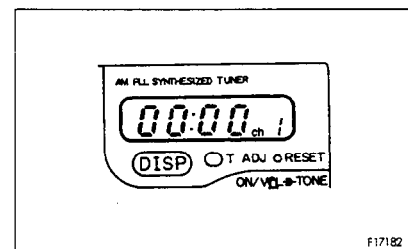

11.14.2 METHOD OF USE

Method of setting preset buttons

1. Press power switch ①. The frequency is displayed in display area ②.
2. Use selector button ③ (\wedge or \vee) to adjust to the desired frequency.
3. Choose a preset button to use for this station, and keep it pressed for at least 2 seconds to program the button to that frequency.

When the sound suddenly disappears and appears again, the button is programmed, and the preset number is shown in display area ②.

After programming the button, press the preset button and release it within approx. 2 sec. The station programmed to that button will be selected for reception.

It is possible to program one station for each preset button.

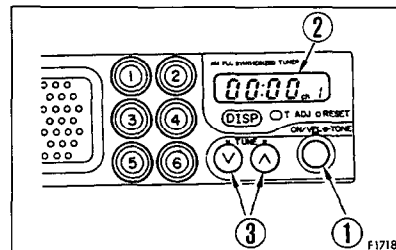

Method of manual tuning

Press the tuning button lightly to adjust to the desired frequency. Each time the button is pressed, the frequency will change by 9 kHz.

\wedge button: Select station at higher frequency

\vee button: Select station at lower frequency

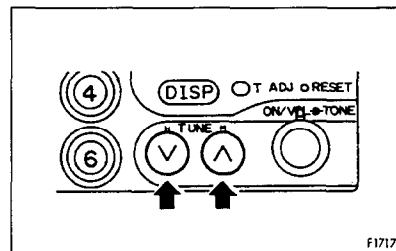

Method of automatic tuning

Keep the tuning button pressed for at least 2 seconds and then release it. When reception from a broadcasting station is picked up, the selector will automatically stop at that position.

When searching for the next station, keep the selector button pressed again for at least 2 seconds.

\wedge button: Select station at higher frequency

\vee button: Select station at lower frequency

If the reception is weak, and stations are not found, adjust the frequency manually to select the desired station.

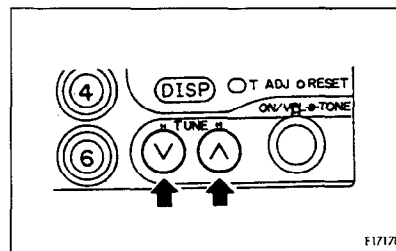

Adjusting time

1. Keep T.ADJ button ① pressed, and press H button ②.
The hour display will change, so when it reaches the correct hour, release the button.
2. Keep T.ADJ button ① pressed and press M button ③.
The minute display will change, so when it reaches the correct time, release the button.

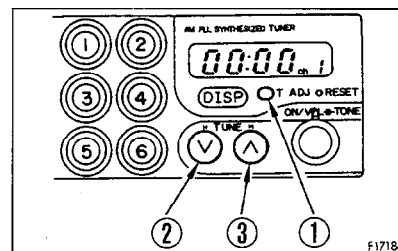

Method of using RESET button

If RESET button ① is pressed at the same time as the time signal or standard time, the display will return immediately to the exact hour (○ hour 00 min).

If the display is 01 – 29 min, the display will go back to 0 min.

If the display is 30 – 59 min, the display will advance to 0 min.

[Example]

10:29 → 10:00 (return to exact hour)

10:30 → 11:00 (advances to exact hour)

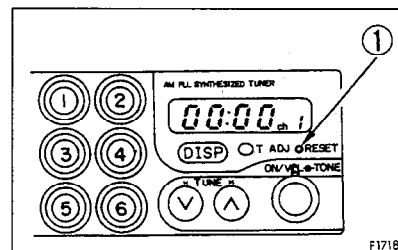

11.14.3 PRECAUTIONS WHEN USING

- For safety reasons, when operating keep the sound to a level where you can enjoy the sound but still hear the sound from outside vehicles.
- If water gets inside the speaker case or car radio (auto tuning), it may cause a serious problem, so do not let water get on these parts.
- Do not wipe the knobs or buttons or any other parts with any solvent such as benzene or thinner. Always wipe with a soft dry cloth (in cases of extreme dirt, use alcohol on the cloth).

11.14.4 SPECIFICATION

Tuning method: PLL synthesizer method

Reception frequency: 522 kHz – 1629 kHz

Intermediate frequency: 450 kHz

Rated output: 3 W

Max. output: 5 W

Voltage: DC26.4V (21.6V, 31.2V) (–) ground

Current: Max. 2A

Outside dimensions: Width 178 mm, height 50 mm,
depth 110 mm

Weight: 640 g

11.15 USING CAR STEREO (MACHINES EQUIPPED WITH CAB, CAR STEREO)

11.15.1 EXPLANATION OF PARTS

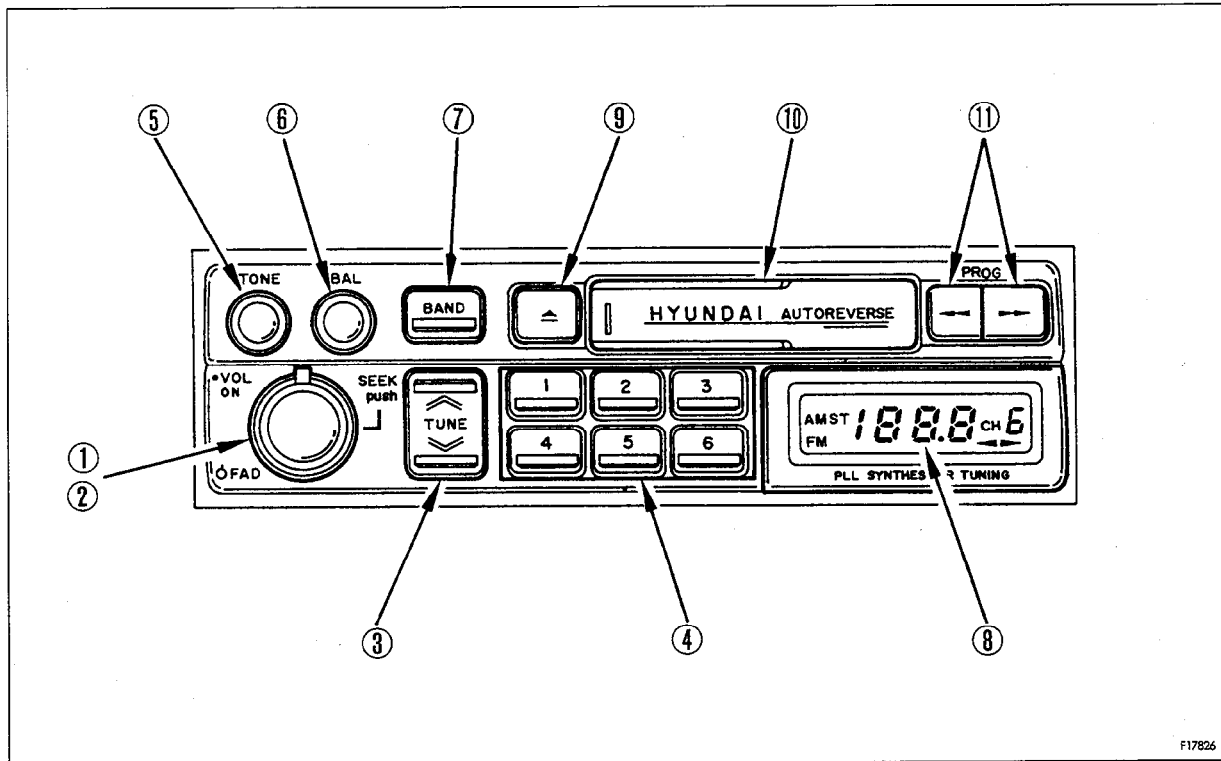

1. POWER/VOLUME CONTROL KNOB (ON/VOL)

When this knob is turned clockwise, the power for the radio comes on, the lighting for display area ① lights up, and the frequency is displayed. If the knob is turned further clockwise, the sound becomes louder.

Turn the knob counterclockwise to reduce the sound. When the knob is turned fully counterclockwise, the power is turned off.

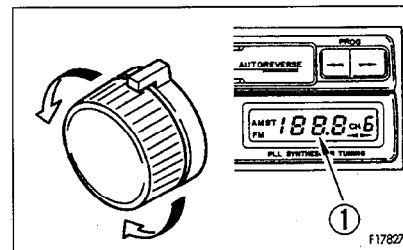

2. AUTOMATIC TUNING BUTTON (SEEK PUSH)

This is used to select the station or change the frequency. When the center of the knob is pressed, it will move to a higher frequency, and when reception from a broadcasting station is picked up, the selector will automatically stop at that position.

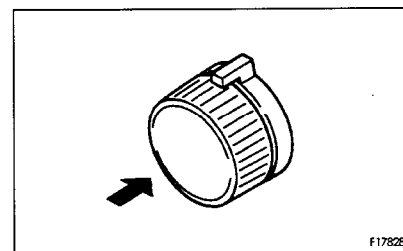

F17826

F17827

F17828

3. MANUAL TUNING BUTTON (TUNE)

This is used to select the station or change the frequency. If the station up button \wedge is pressed, the frequency will go up; if the station down button \vee is pressed, the frequency will go down.

AM

\wedge part: The frequency goes up by 9 kHz each time the button is pressed.

\vee part: The frequency goes down by 9 kHz each time the button is pressed.

FM

\wedge part: The frequency goes up by 0.1 MHz each time the button is pressed.

\vee part: The frequency goes down by 0.1 MHz each time the button is pressed.

REMARK

If the button is held down, the frequency will change continuously.

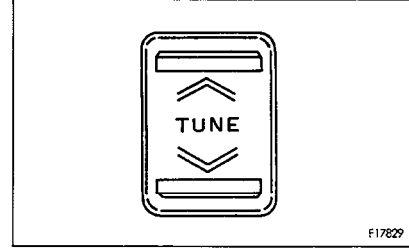

4. PRESET BUTTONS (1, 2, 3, 4, 5, 6)

These buttons can be used to program the desired broadcasting stations. It is then possible to select the station at a touch.

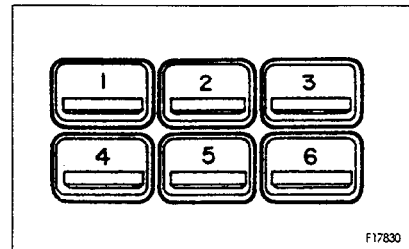

5. TONE ADJUSTMENT KNOB (TONE)

Press this knob and it will spring out. Then turn the knob to adjust the tone.

Turn this knob clockwise from the center position to emphasize the high sounds, and counterclockwise to emphasize the low sounds.

After completing the adjustment, push the knob back in.

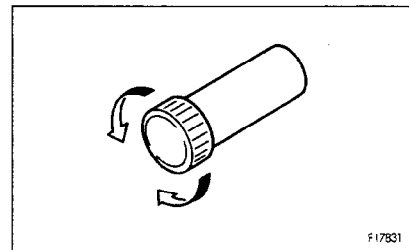

6. LEFT/RIGHT VOLUME ADJUSTMENT KNOB (BAL)

Press this knob and it will spring out. Then turn the knob to adjust the tone.

Turn this knob clockwise, the volume from the R.H. speaker increases. When turned counterclockwise, the volume from the L.H. speaker increases.

After completing the adjustment, push the knob back in.

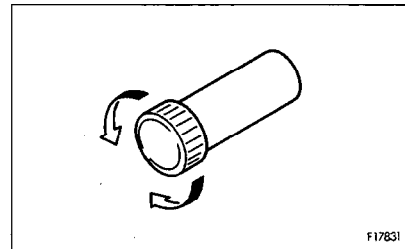

F17831

7. AM/FM SELECTOR BUTTON (BAND)

Each time this button is pressed, it changes between AM and FM.

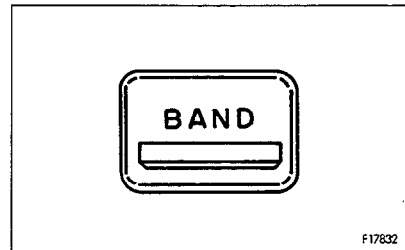

F17832

8. DISPLAY AREA

AM/FM, the frequency, and preset symbols are displayed here. When a cassette is being used, it displays the direction of play for the cassette.

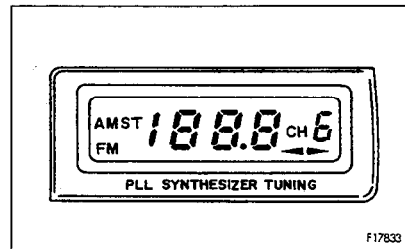

F17833

9. TAPE EJECT BUTTON (▲)

This is used to eject the cassette tape from the car stereo. Press this button and the cassette tape is ejected.

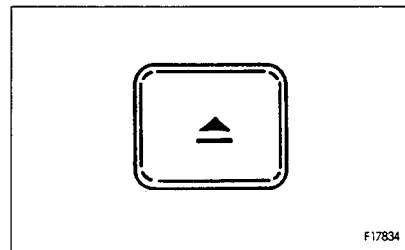

F17834

10. CASSETTE TAPE INSERTION PORT

Insert the cassette tape here. When the cassette tape is set in the insertion port, it is installed inside the car stereo.

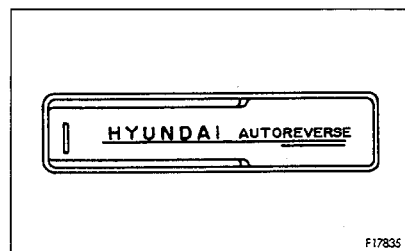

F17835

11. PROGRAM SELECTION, FAST FORWARD (▶) / REWIND (◀) BUTTON

When the "▶" button is pressed, the tape is fast forwarded, and when the "◀" button is pressed, it is wound.

To stop the tape, press the REWIND button lightly when fast forwarding and press the FAST FORWARD button lightly when rewinding.

If both the "◀" button and "▶" button are pressed at the same time, the direction of the tape will be reversed.

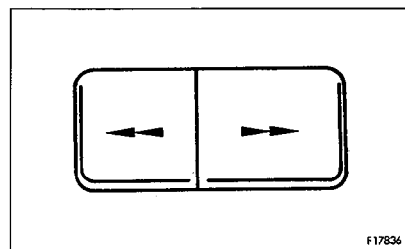

F17836

11.15.2 LISTENING THE RADIO (AM/FM)

1. Turn power switch ① clockwise to turn on the power. Check that display area ② lights up and that letters are displayed.
2. Press AM/FM selector button ③ to select either AM or FM.
3. Press either automatic tuning button ④ or manual tuning button ⑤ to set to the desired frequency. If the desired station frequency is set to preset button ⑥, press preset button ⑥ to select the station.

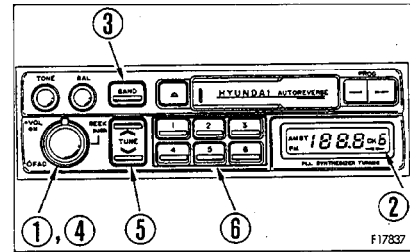

REMARK

To receive a station where the signal is weak, press the manual tuning button to adjust the frequency.

4. Adjust the volume, tone, left/right balance as desired.
5. To stop the radio, turn power switch ① completely counterclockwise to turn off the power. When the power is turned off, the display in display area ② goes out.

Method of presetting

1. Press automatic tuning button ① or manual tuning button ② to set to the desired frequency.
2. Choose a preset button ③ to use for this station, and keep it pressed for at least 2 seconds to program the button to that frequency. When the sound suddenly disappears and appears again, the button is programmed, and the preset number is shown in display area ④.

After programming the button, press the preset button and release it within approx. 2 sec. The station programmed to that button will be selected for reception.

It is possible to program one station for each preset button.

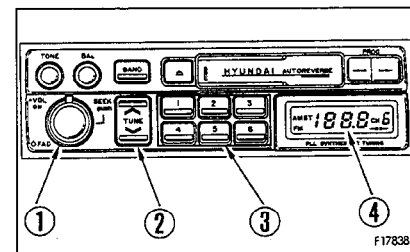

11.15.3 LISTENING TO CASSETTE TAPE

1. Turn power switch ① clockwise to turn on the power. Check that display area ② lights up and that letters are displayed.
2. Set the cassette tape into insertion port ③ and insert it into the car stereo. The direction of play of the tape is displayed in display area ②, and the tape plays.
3. Find the beginning of the tape as follows.
 - Fast forward: Press fast forward button ④.
 - Rewind: Press rewind button ⑤.
 - Change direction of play (change between A side and B side of cassette tape): Press fast forward button ④ and rewind button ⑤ at the same time.
4. Adjust the volume, tone, left/right balance as desired.
5. When stopping the tape, press tape eject button ⑥ and remove the cassette tape. After removing the tape, turn power switch ① completely counterclockwise to turn off the power. When the power is turned off, the display in display area ② goes out.

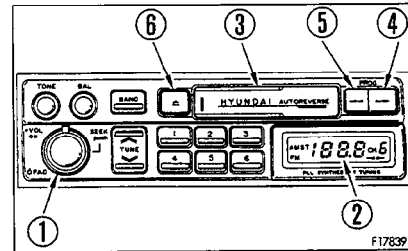

11.15.4 PRECAUTIONS WHEN USING

- If the head is dirty, clean it with a head cleaning tape.
- Never touch the head with a magnet, screwdriver, or any other hard object.
- Use a pencil to wind the tape to the outside to remove any slack.
- When not listening to the cassette tape, always remove it.
- Put the tape in its case. Do not keep the tape in any of the following places.
 - On top of the instrument panel
 - Any place where it is exposed to direct sunlight
 - Any place that is excessively humid
 - Any place that is excessively dusty
 - Any place where there is a strong magnetic field (near a speaker, etc.)
 - Any place where there is high temperature (near the car heater, etc.)
- Use a C-60 (60 minute) tape. Avoid using longer tapes as far as possible. In particular, do not use C-120 (120 minute) tapes. These tapes easily get caught up in the machine.
- When replacing the fuse, always use a 5A fuse.
- Do not put anything except a cassette tape in the tape insertion port.
- When cleaning, wipe off the dirt with a dry cloth. Never use any organic solvent such as thinner or benzene.

11.15.5 SPECIFICATIONS

Radio

- FM

Reception frequency: 87.9 – 107.9 MHz

Intermediate frequency: 10.7 MHz

Sensitivity: 5 dB μ EMF

S/N ratio: Min. 55 dB (stereo)

Min. 60 dB (monaural)

Distortion factor (1 kHz): Max. 0.5% (stereo)

Max. 0.2% (monaural)

Separation (1 kHz): Min. 30 dB

Frequency characteristics: 20 – 15000 Hz

- AM

Reception frequency: 531 – 1602 kHz

Intermediate frequency: 450 kHz

Sensitivity: 28 dB μ EMF

S/N ratio: Min. 50 dB

Distortion factor: Max. 0.5%

Tape

Tape: 4 track, 2 channel, compact cassette tape

Wow & Flutter: Max. 0.25% (WRMS)

S/N ratio: Min. 50 dB

Cross talk: Min. 40 dB

Frequency characteristics: 30 – 12000 Hz

Others

Max. output: 15 W + 15 W

Voltage: DC 24V (22V – 32V)

Current: 5A (at max. output)

Speaker impedance: 4 Ω x 2

Outside dimensions: Width 178 mm, height 50 mm,
depth 125 mm

Weight: 1.4 kg

11.16 HANDLING AIR CONDITIONER (MACHINES EQUIPPED WITH CAB)

11.16.1 COOLING OPERATION

When the cooling operation is carried out, the inside of the cab is cooled, and at the same time the drinks inside the hot and cool box can be cooled.

Cooling (RECIRC)

When the control switch and lever are operated as shown in the diagram, a cool breeze is sent out.

Use this position when strong cooling is needed.

- Press switch ②.
- Place levers ① and ④ in the position shown in the diagram.
- Set switch ③ to the desired position.

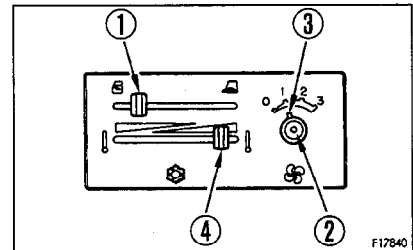

Cooling (FRESH)

If the air inside the cab is no longer fresh, set FRESH/RECIRC selector lever ① to FRESH to bring in fresh air. Keep the other switches at the same positions as for cooling (RECIRC).

In this position, the inside of the cab is pressurized to prevent the entry of dust.

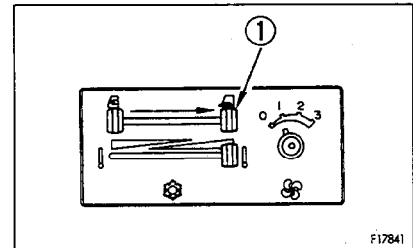

REMARK

If the cooling effect is reduced, set FRESH/RECIRC selector lever ① to RECIRC again. This increases the cooling effect.

11.16.2 HEATING OPERATION

When the heating operation is carried out, the inside of the cab is heated, and at the same time the drinks inside the hot and cool box can be heated.

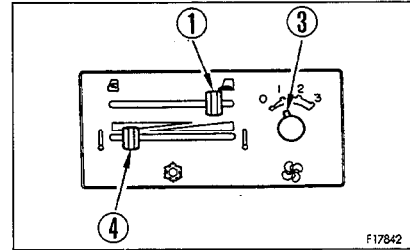

Heating (RECIRC)

When the control switch and lever are operated as shown in the diagram, warm air is sent out. Use this position when strong cooling is needed.

- Place levers ① and ④ in the position shown in the diagram.
- Set switch ③ to the desired position.

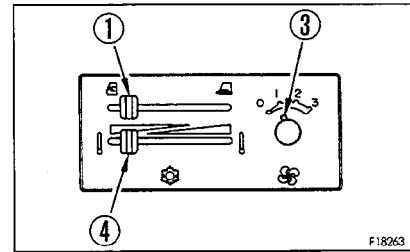

Heating (FRESH)

If the air inside the cab is no longer fresh, set FRESH/RECIRC selector lever ① to FRESH to bring in fresh air. Keep the other switches at the same positions as for heating (RECIRC). In this position, the inside of the cab is pressurized to prevent the entry of dust.

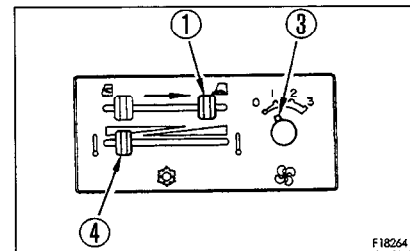

REMARK

If the cab is not heated up sufficiently, turn FRESH/RECIRC selector lever ① back to RECIRC. This increases the heating effect.

Dehumidifying and heating

Push switch ②. When temperature control lever ④ is placed at the central position, dry warm air blows out. Keep the other switches at the same positions as for heating (FRESH).

REMARK

If this is used in spring and fall on rainy days when the air inside the cab is damp, there is no problem of the windows misting up, and the cab be warmed up to a comfortable temperature.

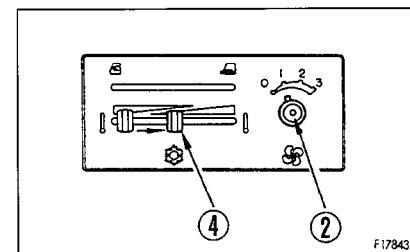

11.16.3 PRECAUTIONS WHEN USING AIR CONDITIONER

Carry out ventilation from time to time when using the cooler.

- If you smoke when the cooler is on, the smoke may start to hurt your eyes, so turn the lever to FRESH to remove the smoke while continuing the cooling.
- When running the air conditioner for a long time, turn the lever to the FRESH position once an hour to carry out ventilation and cooling.

Be careful not to make the temperature in the cab too low.

- When the cooler is on, set the temperature so that it feels slightly cool when entering the cab (5 – 6°C lower than the outside temperature). This temperature difference is considered to be the most suitable for your health, so always be careful to adjust the temperature properly.

Direction of vents when cooling

- If the vents (left and right) in the middle of the dashboard are turned so that cold air plays directly on the cab door glass, moisture may condense on the outside of the cab door glass and reduce the visibility. (This occurs particularly in high temperatures.)
If this happens, turn the vent fully to the rear and raise the air conditioner temperature setting slightly.

11.16.4 INSPECTION DURING OFF-SEASON

Even during the off-season, run the compressor at low speed for several minutes once a week to prevent the loss of the oil film at the lubricated parts of the compressor. (Run the engine at low speed and set the temperature control lever at the central position.)

REMARK

When the ambient temperature is low, if the compressor is suddenly run at high speed, it may cause failure of the compressor. Note that the system is set so that the compressor will not run when the cooler switch is turned on if the ambient temperature is less than 2 – 6.5°C.

11.16.5 PROCEDURE FOR REPLACING RECEIVER

Replace the receiver once every two years.
After replacing the receiver, add compressor oil. Turn the receiver at an angle and measure the oil remaining inside the receiver, then add the same amount of oil (Denso Oil 6) to fill the receiver.

REMARK

Depending on the condition of use, the replacement interval may be shorter.

REMARK

If the receiver is used when the desiccant has exceeded the water absorption limit, the refrigerant circuit may become clogged and cause failure of the compressor.

Precautions when replacing receiver

- If the receiver is left for more than 15 minutes with the blind cover removed, the moisture in the air will be absorbed, and this will reduce the life of the desiccant. If you remove the blind cover, connect the piping quickly, evacuate the system and fill with refrigerant.
- When removing the refrigerant from the refrigerant circuit, release it gradually from the low pressure side to prevent oil from flowing out.

11.16.6 CLEANING AIR FILTER

If the air filter for the FRESH or RECIRC air intake becomes clogged, the cooling or heating capacity will drop. To prevent this, clean the air filter with compressed air once a week.

For details of the cleaning method, see "24.1 WHEN REQUIRED".

11.17 HANDLING HEATER (MACHINES EQUIPPED WITH CAB)

11.17.1 METHOD OF OPERATION

To heat quickly

Set the switches to the position shown in the diagram on the right to carry out heating quickly.

- Set FRESH/RECIRC selector lever ① and temperature control lever ③ to the position in the diagram on the right.
- Set blower switch ② to position 3 (HIGH).

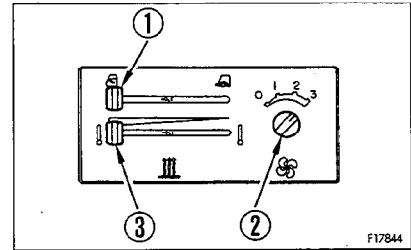

NOTICE

If heating is carried out continuously for a long period with the lever at the RECIRC position, the air inside the cab will become stale, so when the cab is warmed up, always set the FRESH/RECIRC selector lever ① to the FRESH position.

In this position, the inside of the cab is pressurized to prevent the entry of dust.

Normal use

Set each switch to the desired position.

11.17.2 CLEANING AIR FILTER

If the air filter for the FRESH or RECIRC air intake becomes clogged, the heating capacity will drop. To prevent this, clean the air filter with compressed air once a week.

For details of the cleaning method, see "24.1 WHEN REQUIRED".

12. OPERATION

12.1 CHECKS BEFORE STARTING ENGINE

12.1.1 WALK-AROUND CHECK

⚠ WARNING

- Leakage of oil or fuel, or accumulation of flammable material around high temperature parts, such as the engine muffler or turbocharger, may cause fire. Check carefully, and if any abnormality is found, repair it or contact your Komatsu distributor.
- Do not get on or off the machine from the rear. Using this position is dangerous because it is easy to slip and you cannot be seen from the operator's compartment. Always use the handrail and step at the side when getting on or off the machine.

Before starting the engine, look around the machine and under the machine to check for loose nut or bolts, or leakage of oil, fuel, or coolant, and check the condition of the work equipment and hydraulic system. Check also for loose wiring, play, and collection of dust at places which reach high temperatures.

Always carry out the items in this section before starting the engine each day.

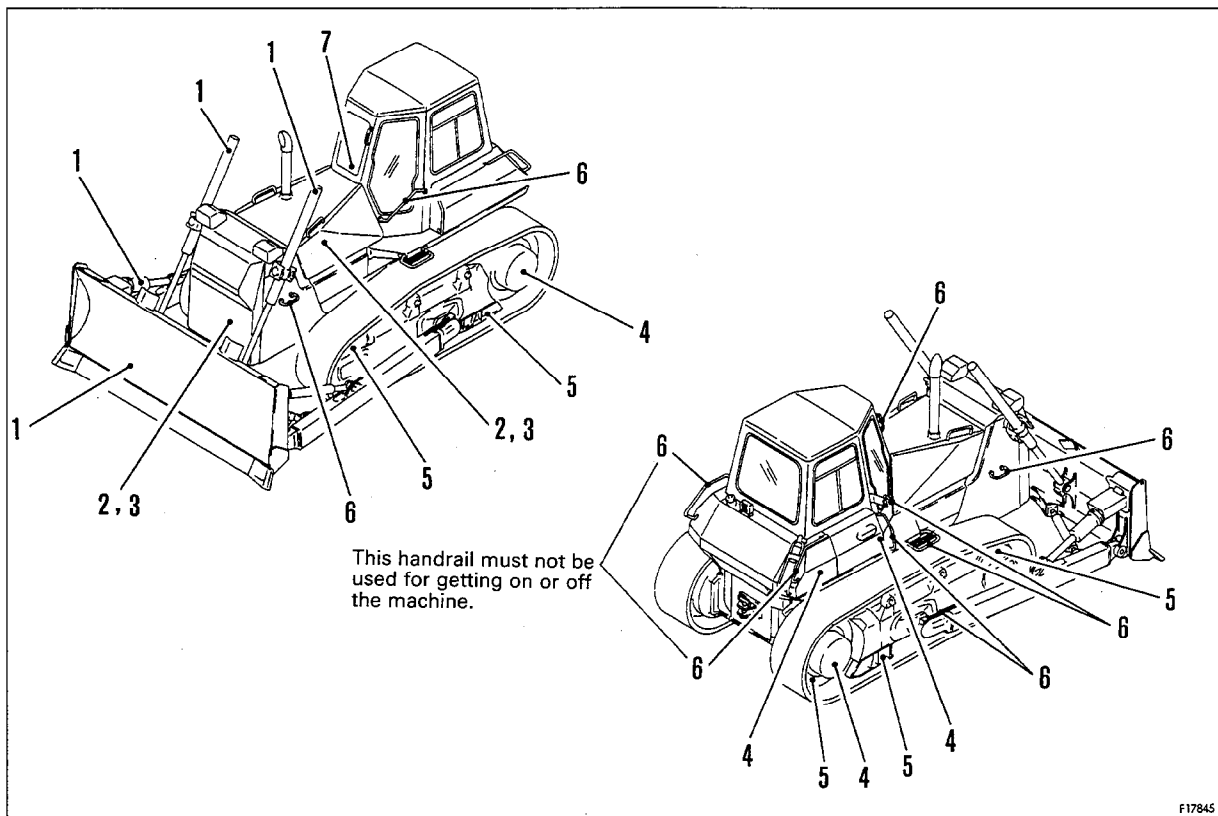

F17845

1. Check for damage, wear, play in work equipment, cylinders, linkage, hoses

Check that there are no cracks, excessive wear, or play in the work equipment, cylinders, linkage, or hoses. If any abnormality is found, repair it.

2. Remove dirt and dust from around engine, battery radiator

Check if there is any dirt or dust accumulated around the engine or radiator. Check also if there is any flammable material (dead leaves, twigs, grass, etc.) accumulated around the battery or high temperature engine parts, such as the engine muffler or turbocharger. Remove all such dirt or flammable material.

3. Check for leakage of water or oil around engine

Check that there is no leakage of oil from the engine or leakage of water from the cooling system. If any abnormality is found, repair it.

4. Check for oil leakage of oil from power train case, final drive case, hydraulic tank, hose, joints

Check that there is no oil leakage. If any abnormality is found, repair the place where the oil is leaking.

Check for leakage of oil from the undercover. Check the ground for traces of oil leakage.

5. Check the undercarriage (track, sprocket, idler, guard) for damage, wear, loose bolts, or leakage of oil from rollers

If any damage, wear, or oil leakage is found, repair the problem and tighten the bolts.

6. Check for damage to handrail, loose bolts

Repair any damage and tighten any loose.

7. Check for damage to gauges, lamps on instrument panel, loose bolts

Check that there is no damage to the panel, gauges and lamps. If any abnormality is found, replace the parts. Clean off any dirt on the surface.

8. Check for damage to seat belt and mounting clamps

Check that there is no abnormality in the seat belt or mounting clamps. If there is any damage, replace with new parts.

12.1.2 CHECK BEFORE STARTING

Always carry out the items in this section before starting the engine each day.

CHECK AND REFILL COOLANT

⚠ WARNING

Normally, do not open the radiator cap. When checking the cooling water level, check the sub-tank when the engine is cold.

1. Open the engine side cover on the right side of the chassis, and check that the cooling water is between the FULL and LOW marks on sub-tank ①. If the water level is low, add water to the FULL level through the water filler port in sub-tank ①.

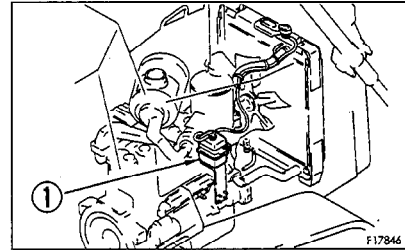

REMARK

In summer, the coolant may overflow from the sub-tank drain hose. This is no problem. It occurs because too much coolant has been added.

2. After adding water, tighten the cap securely.
3. If the sub-tank is empty, check for leakage of water, then add water to the radiator and sub-tank.
4. After adding water, close the engine side cover.

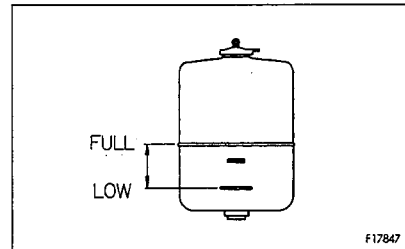

CHECKING WITH MACHINE MONITOR (MONITOR PANEL SPECIFICATION)

1. Turn starting switch ① to the ON position.
2. Check that all monitor lamps light up for 3 seconds, the warning lamp lights up for 2 seconds, and the alarm buzzer sounds for 1 second.

REMARK

- If the lamps do not light up, there may be a failure or disconnection in the monitor, so please contact your Komatsu distributor.
- When carrying out the checks before starting, do not rely only on the monitor. Always carry out all the items listed for periodic maintenance.

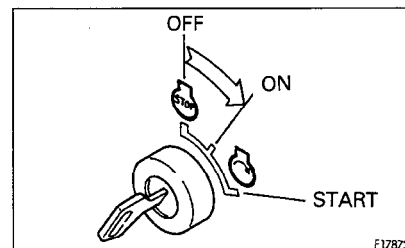
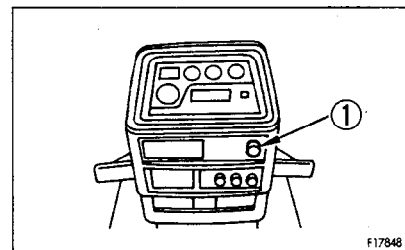

CHECK FUEL LEVEL, ADD FUEL (MONITOR PANEL SPECIFICATION)

⚠ WARNING

When adding fuel, never let the fuel overflow. This may cause a fire. If you spill fuel, thoroughly clean up any spillage.

1. Turn the engine starting switch to the ON position and check the fuel level with fuel level gauge ⑥ on the monitor panel.
After checking, turn the switch back to the OFF position.
2. After completing work, fill the fuel tank through oil filler port ⑤.
For details of the method of opening and closing the cap, see "11.9 CAP WITH LOCK".
For details of the fuel to use, see "20. USE OF FUEL, COOLANT AND LUBRICANTS ACCORDING TO AMBIENT TEMPERATURE".
3. After adding fuel, tighten the cap securely.
Fuel capacity: 340 ℓ

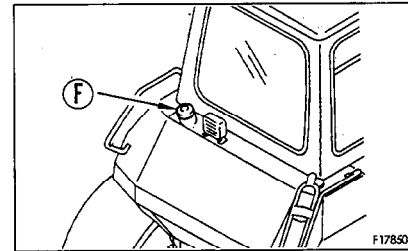
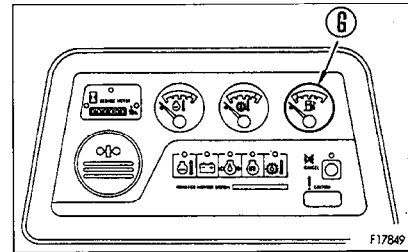

CHECK FUEL LEVEL, ADD FUEL (GAUGE PANEL SPECIFICATION)

⚠ WARNING

When adding fuel, never let the fuel overflow. This may cause a fire. If you spill fuel, thoroughly clean up any spillage.

1. Removed the cap and check the fuel level using fuel gauge ⑥.
For details of the method of opening and closing the cap, see "11.9 CAP WITH LOCK".
2. After completing work, fill the fuel tank through oil filler port ⑤.
For details of the fuel to use, see "20. USE OF FUEL, COOLANT AND LUBRICANTS ACCORDING TO AMBIENT TEMPERATURE".
3. After adding fuel, tighten the cap securely.
Fuel capacity: 340 ℓ

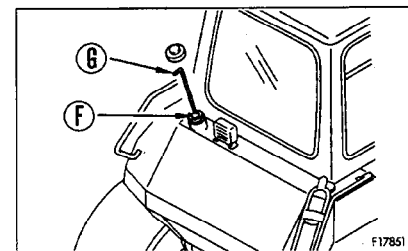

CHECK OIL LEVEL IN ENGINE OIL PAN, ADD OIL

1. Open the engine side cover on the left side of the chassis.
2. Remove dipstick ③ and wipe the oil off with a cloth.
3. Insert dipstick ③ fully in the oil filler pipe, then take it out again.

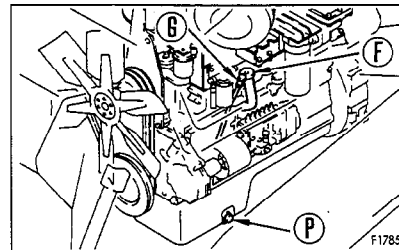

4. The oil level should be between the H and L marks on dipstick ③.
If the oil level is below the L mark, add engine oil through oil filler ⑤.
For details of the oil to use, see "20. USE OF FUEL, COOLANT AND LUBRICANTS ACCORDING TO AMBIENT TEMPERATURE".
5. If the oil is above the H mark, drain the excess engine oil from drain plug ⑥, and check the oil level again.
6. If the oil level is correct, tighten the oil filler cap securely and close the engine side cover.

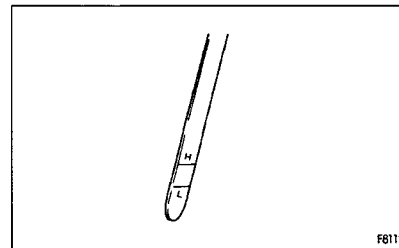

REMARK

When checking the oil level after the engine has been operated, wait for at least 15 minutes after stopping the engine before checking.

If the machine is at an angle, make it horizontal before checking.

CHECK OIL LEVEL IN POWER TRAIN CASE, ADD OIL

1. Remove dipstick ⑥, and wipe the oil off with a cloth.
2. Insert dipstick ⑥ fully in the oil filler pipe, then take it out again.

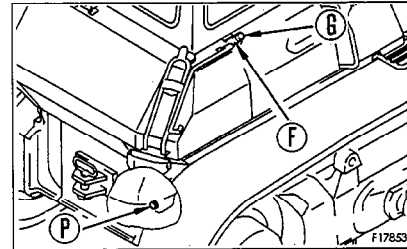

3. The oil level should be between the H and L marks on dipstick ⑥.
If the oil level is below the L mark, add engine oil through oil filler ⑤.
For details of the oil to use, see "20. USE OF FUEL, COOLANT AND LUBRICANTS ACCORDING TO AMBIENT TEMPERATURE".
4. If the oil is above the H mark, drain the excess engine oil from drain plug ④, and check the oil level again.
5. If the oil level is correct, tighten the oil filler cap securely.

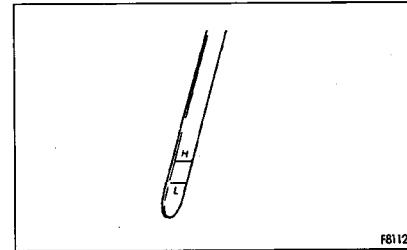
**REMARK**

- When stopping the engine, check the oil level.
- When checking the oil level after the engine has been operated, wait for at least 15 minutes after stopping the engine before checking.
If the machine is at an angle, make it horizontal before checking.

CHECK BRAKE PEDAL TRAVEL

1. Depress the brake pedal all the way until it stops.
2. The distance of travel at the center of the pedal (position in the diagram on the right) should be 70 – 90 mm.
3. When this value exceeds 90 mm, or the brake fails to work, please contact your Komatsu distributor for adjustment.

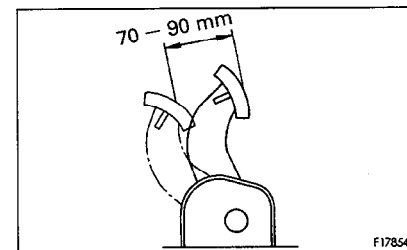
**CHECK DUST INDICATOR**

1. Open the engine side cover on the left side of the chassis, and check that the red piston has not appeared in the transparent portion of dust indicator ①.
2. If the red piston has appeared, clean or replace the element immediately.
For details of the method of cleaning the element, see "24.1 WHEN REQUIRED".
3. After checking, cleaning, and replacing, press the knob of dust indicator ① to return the red piston to its original position.

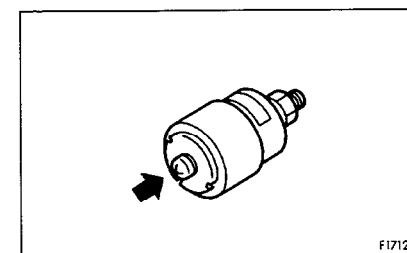
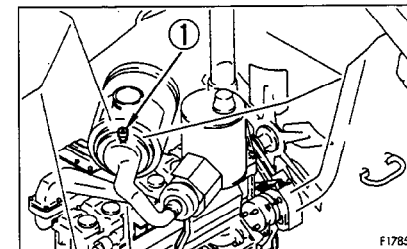

CHECK THAT LAMPS LIGHT UP

Turn the head lamp switch, the rear lamp switch and the additional working lamp to the ON position and check that the head lamps and rear lamps light up.

If the lamps do not light up, there is probably a broken bulb or disconnection in the wiring, so contact your Komatsu distributor for repairs.

CHECK HORN SOUND

CHECK BACKUP ALARM SOUND

CHECK SEAT BELT FOR WEAR OR DAMAGE

Check the belt and mounting clamps, and if they are worn or damaged, replace the seat belt.

CHECK FOR WATER AND SEDIMENT IN WATER SEPARATOR, DRAIN WATER

The water separator separates water mixed in the fuel. If float ② is at or above red line ①, drain the water according to the following procedure:

1. Loosen drain plug ③ and drain the accumulated water until the float reaches the bottom.
2. Tighten drain plug ③.
3. If the air is sucked into fuel line when draining and water, be sure to bleed air in the same manner as for the fuel filter. See "24.5 EVERY 500 HOURS SERVICE".

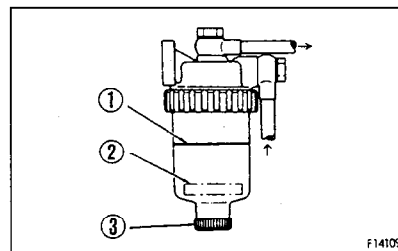

12.1.3 ADJUST OPERATOR'S SEAT

⚠ WARNING

- Adjust the seat position at the beginning of each shift or when operators change.
- Adjust the seat so that the brake pedal can be depressed all the way with the operator's back against the backrest.

Fore-aft adjustment of seat

Set the seat in the desired position by moving lever ① to right; then release the lever.

Fore-aft adjustment: 160 mm (9 stages)

Adjusting cushion

Turn knob ② to adjust the cushion to the desired strength.

Adjusting angle of reclining

NOTICE

When reclining the seat back to the rear, check the space behind, and adjust to a suitable position.

Pull lever ③ up, set the backrest to the desired position, then release the lever.

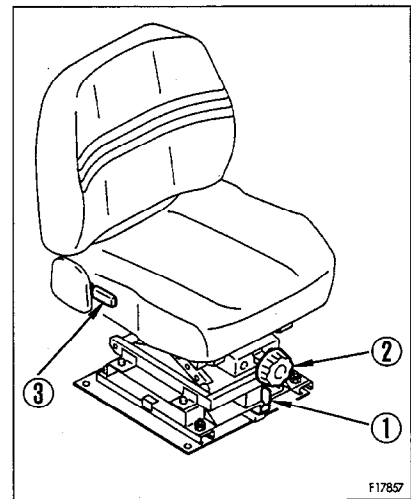

12.1.4 OPERATIONS AND CHECKS BEFORE STARTING ENGINE

⚠ WARNING

If the blade control levers are touched by accident, the work equipment may move suddenly. When leaving the operator's compartment, always set the safety lever securely to the LOCK position.

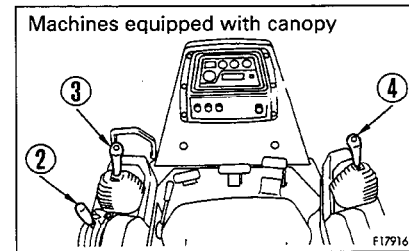
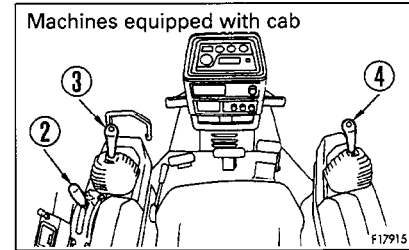
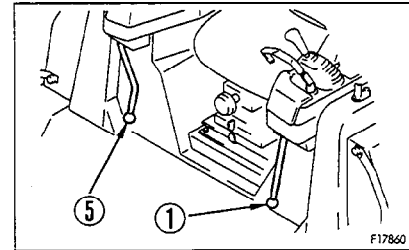

1. Check that the brake pedal is locked with parking lever ①. If they are not at these positions the engine will not start.

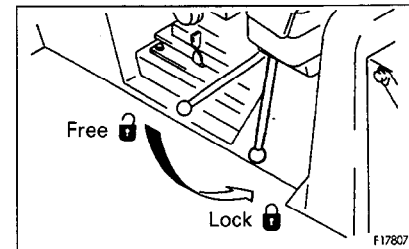

2. Check that gear shift lever ② is at the 1st speed position.

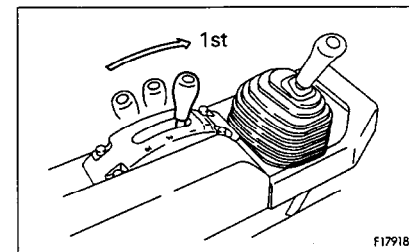

3. Check that steering and directional lever ③ is the N (neutral) position.

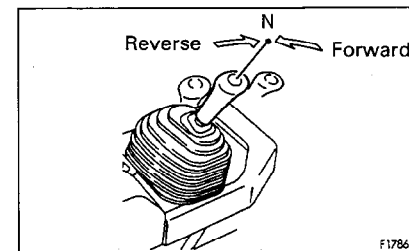

4. Check that the blade is lowered to the ground and that blade control lever ④ is at the HOLD position. If it is at the FLOAT position, the engine will not start.

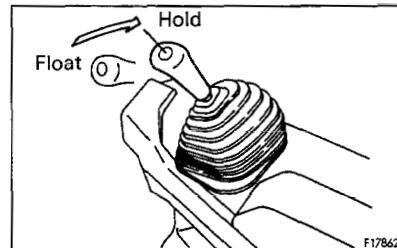

5. Check that safety lever ⑤ is at the LOCK position.

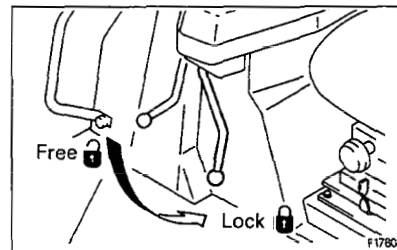

12.2 STARTING ENGINE

12.2.1 NORMAL STARTING

⚠ WARNING

Check that there are no persons or obstacles in the surrounding area, then sound the horn and start the engine.

NOTICE

Do not keep the starting motor rotating continuously for more than 20 seconds.

If the engine will not start, wait for at least 2 minutes before trying to start the engine again.

1. Pull fuel control lever ① to the center position between LOW IDLING and HIGH IDLING.

2. Insert the key into starting switch ② and turn the key to the START position. The engine will start.

3. When the engine starts, release the key in starting switch ②. The key will return automatically to the ON position.

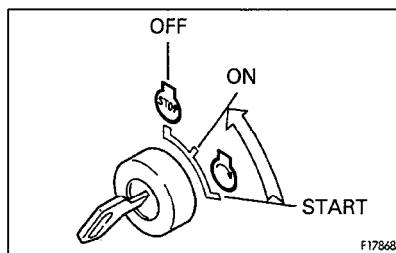
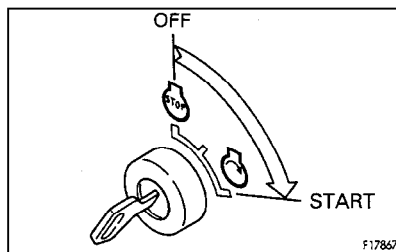
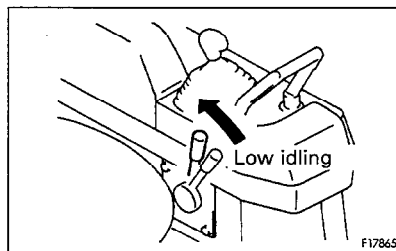
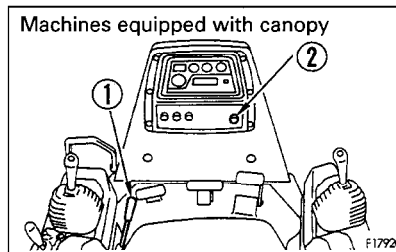
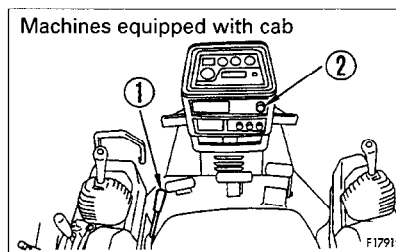

12.2.2 STARTING IN COLD WEATHER (MONITOR PANEL SPECIFICATION)

When starting in low temperatures, do as follows.

WARNING

Never use starting aid fluids as they may cause explosions.

NOTICE

Do not keep the starting motor rotating continuously for more than 20 seconds.

If the engine fails to start, repeat steps 2 and 3 after waiting for about 2 minutes.

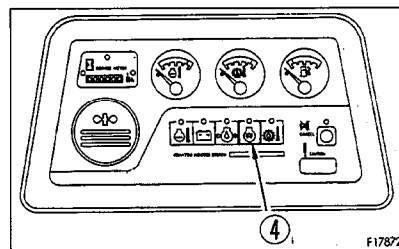
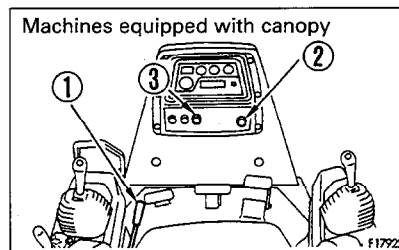
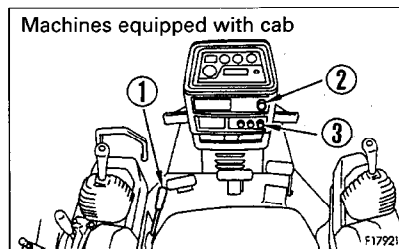

1. Pull fuel control lever ① to the center position between LOW IDLING and HIGH IDLING.

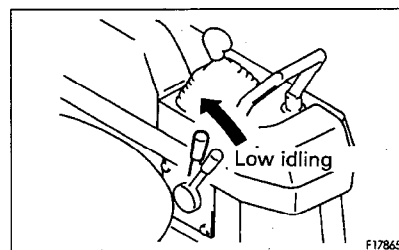

2. Insert the key into starting switch ② and turn the key to the START position.

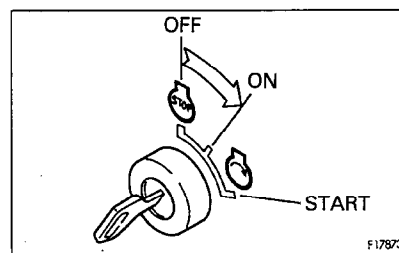

3. Carry out preheating.
There are the following two ways of carrying out preheating. First use the convenient automatic preheating system.

12. OPERATION

- Automatic preheating

- (1) Turn glow switch ③ to the AUTO position.

When it is turned to the AUTO position, preheating is automatically carried out according to the ambient temperature. Lamp ④ lights up during the preheating operation. When the preheating is completed, lamp ④ will go out.

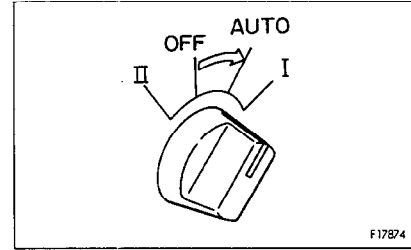

- (2) When the preheating is completed, turn the key in starting switch ② to the START position to start the engine.

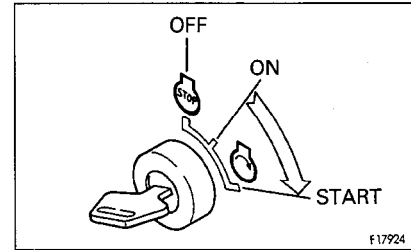

- (3) After starting the engine, return glow switch ③ to the OFF position.

REMARK

If the engine can not start after automatic preheating, start it using manual preheating.

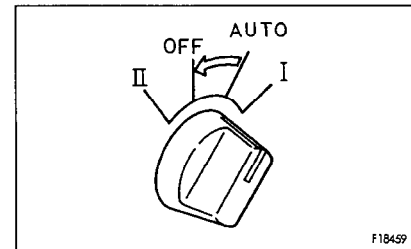

- Manual preheating

- (1) Turn glow switch ③ to position I or II.

Lamp ④ lights up during the preheating operation.

When the preheating is completed, release the switch. The key will then return automatically to the following position.

From position I, it will return to AUTO

From position II, it will return to OFF

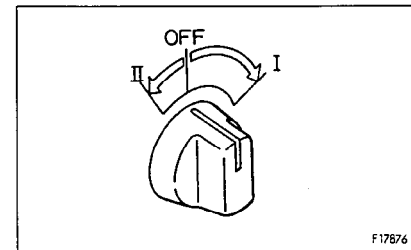

The preheating times are as shown below.

Ambient temperature	Preheat time
0°C to -5°C	—
-5°C to -10°C	15 seconds
-10°C to -20°C	30 seconds
-20°C to -30°C	45 seconds

If the preheating time is too long or too short, the engine will not start easily. Observe the correct preheating time.

- (2) When the preheating is completed, turn the key in starting switch ② to the START position to start the engine.

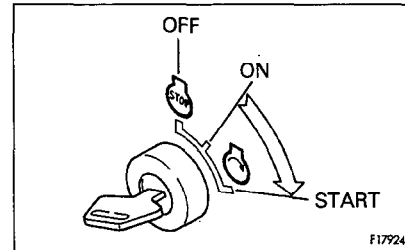

4. When the engine starts, release the key in starting switch ②. The key will return automatically to the ON position.

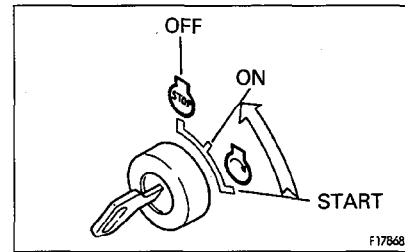

12.2.3 STARTING IN COLD WEATHER (GAUGE PANEL SPECIFICATION)

When starting in low temperatures, do as follows.

WARNING
Never use starting aid fluids as they may cause explosions.

NOTICE

Do not keep the starting motor rotating continuously for more than 20 seconds.

If the engine fails to start, repeat steps 2 and 3 after waiting for about 2 minutes.

1. Pull fuel control lever ① to the center position between LOW IDLING and HIGH IDLING.

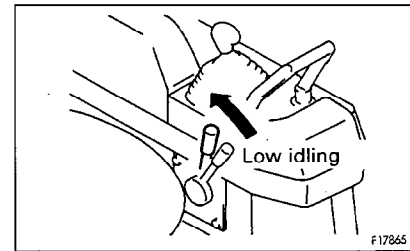
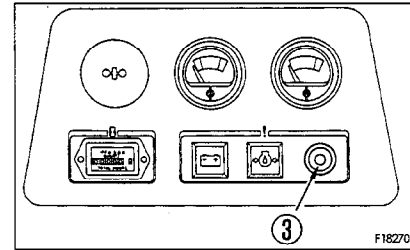
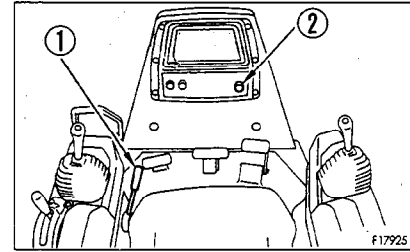

2. Insert the key into starting switch ②, turn the key of starting switch ② to the HEAT position and hold it until glow signal ③ glows red.

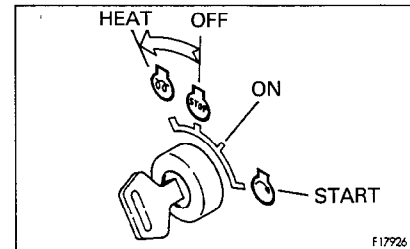

The preheating times are as shown below.

Ambient temperature	Preheat time
0°C to -5°C	—
-5°C to -10°C	15 seconds
-10°C to -20°C	30 seconds
-20°C to -30°C	45 seconds

If the preheating time is too long or too short, the engine will not start easily. Observe the correct preheating time.

3. When glow signal ③ becomes red, turn the key of starting switch ② to the START position and start the engine.

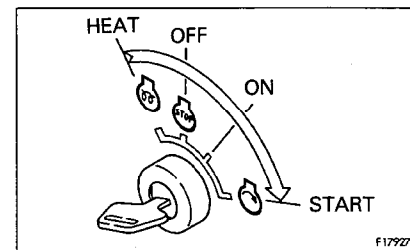

4. When the engine starts, release the key in starting switch
②. The key will return automatically to the ON position.

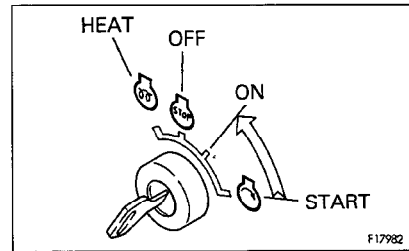

12.3 OPERATIONS AND CHECKS AFTER STARTING ENGINE

After starting the engine, do not immediately start operations. First, carry out the following operations and checks.

NOTICE

Avoid abrupt acceleration until warm-up run is completed.

Do not run the engine at low idling or high idling for more than 20 minutes. If it is necessary to run the engine at idling, apply a load or run at a medium speed from time to time.

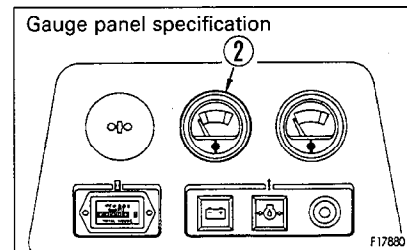
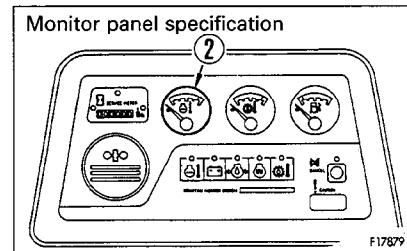
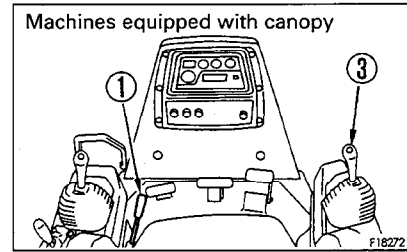
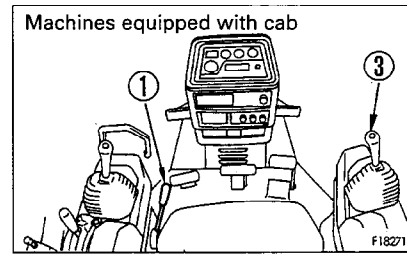

12.3.1 NORMAL OPERATION

1. Pull fuel control lever ① to the center position between LOW IDLING and HIGH IDLING and run the engine at medium speed for about 5 minutes with no load.
2. After warm-up run is completed, check gauges and caution lamps for proper operation. If any abnormality is found, repair it.
Continue to run the engine at light load until engine water temperature gauge indicator ② falls within the white range (monitor panel specification) or the green range (gauge panel specification).
3. Check that there is no abnormal exhaust gas color, noise, or vibration. If any abnormality is found, repair it.

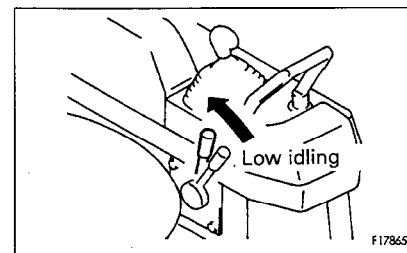

12.3.2 WHEN STARTING IN COLD WEATHER

1. Pull fuel control lever ① to the center position between LOW IDLING and HIGH IDLING and run the engine at medium speed for about 10 minutes with no load.

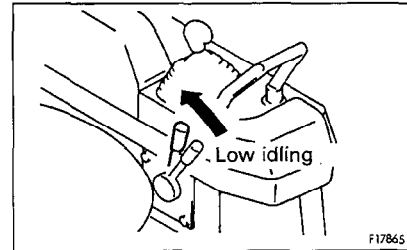

2. Operate blade control lever ③ for 5 minutes to relieve the tilt circuit intermittently, then operate lift + tilt for a further 5 minutes.

If the work equipment oil is not sufficiently warmed up, there will be a delay in the response of the work equipment and steering.

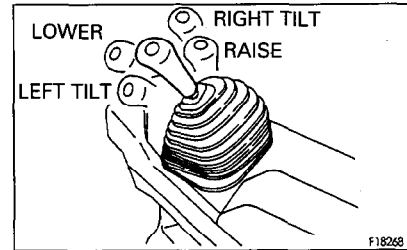

3. After warm-up run is completed, check gauges and caution lamps for proper operation. If any abnormality is found, repair it.

Continue to run the engine at light load until engine water temperature gauge indicator ② falls within the white range (monitor panel specification) or the green range (gauge panel specification).

4. Check that there is no abnormal exhaust gas color, noise, or vibration. If any abnormality is found, repair it.

12.4 MOVING MACHINE

WARNING

- When moving machine, check that the area around the machine is safe, and sound the horn before moving. Clear all personnel from the machine and the area. Clear all obstacles from the path of the machine. Use extreme care when reversing the machine. Note there is an blind spot behind the machine.
- When starting on slopes, always keep brake pedal ② depressed even after releasing parking lever ①.
- When starting the machine on a steep uphill grade, run the engine at full-throttle and shift gear shift lever ③ into 1st and move steering and directional lever ④ to the F (forward) position with brake pedal ② depressed. When the machine has started slowly (or track shoes are slipping), propel the machine by slowly releasing brake pedal ②.

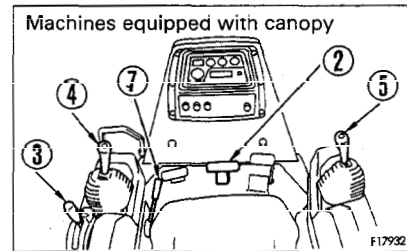
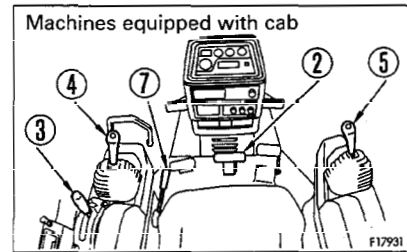
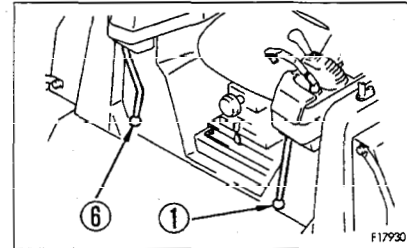

1. Set parking lever ① to the FREE position.

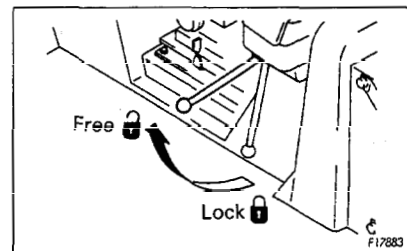

2. Move gear shift lever ③ to the desired position.

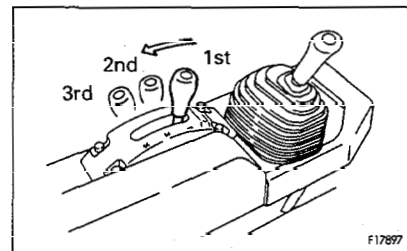

3. Set safety lever ⑥ for blade control lever ⑤ to the FREE position.

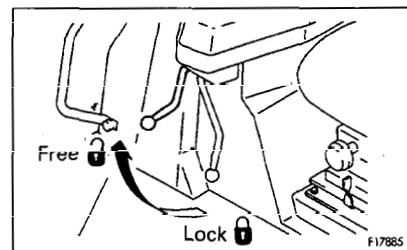

- Put blade control lever ⑤ in the RAISE position to raise the blade 400 to 500 mm off the ground.

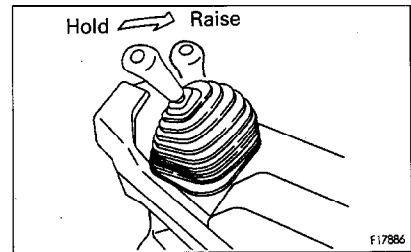

- Move steering and directional lever ④ to the F (forward) or R (reverse) position to move the machine off.

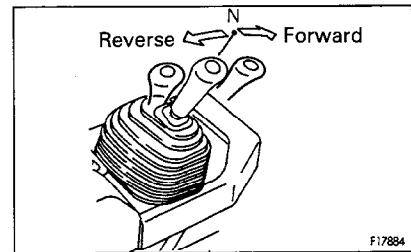

- Pull fuel control lever ⑦ to increase engine speed.

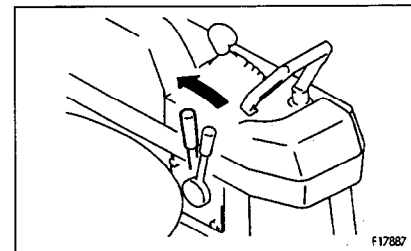

12.5 SHIFTING GEAR

There is no need to stop machine to shift gears.

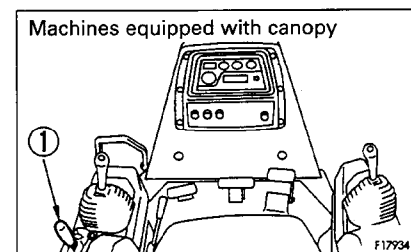
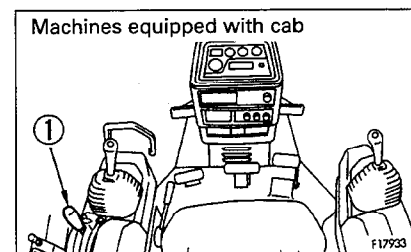

Set gear shift lever ① in the desired position to shift gear.

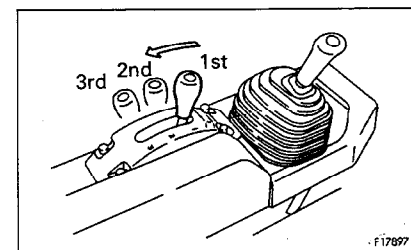

12.6 SHIFTING BETWEEN FORWARD AND REVERSE

CAUTION

When shifting between forward and reverse, for safety reasons and to reduce shock, stop the machine first, then change the direction of travel.

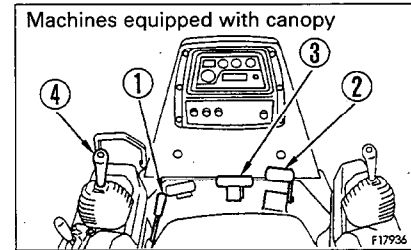
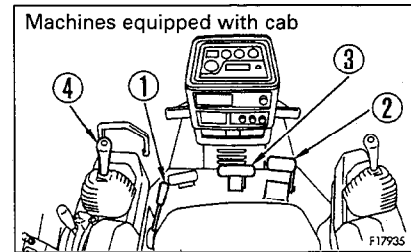

1. Set fuel control lever ① to the LOW IDLING position or depress decelerator pedal ② to reduce the engine speed.

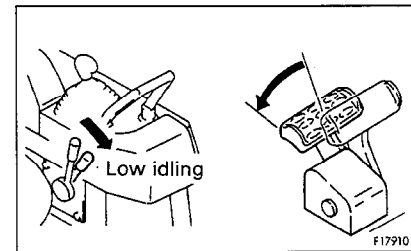

2. Depress brake pedal ③ to apply the brake.
3. Move steering and directional lever ④ to the N position, depress brake pedal ③ further, and stop the machine.

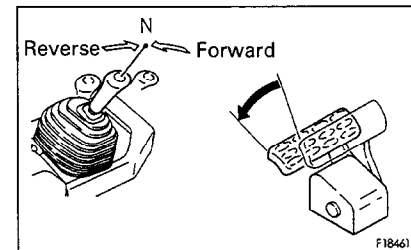

4. Shift steering and directional lever ④ to the desired position.

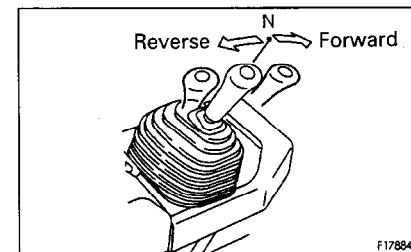

5. Pull fuel control lever ① or release decelerator pedal ② to raise the engine speed.

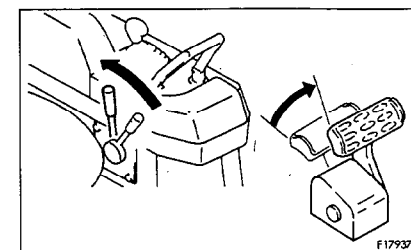

12.7 STEERING MACHINE

⚠ WARNING

- Avoid as much as possible turning the machine on a slope. The machine will tend to slip sideways. Particular care should be taken on soft or clay land.
- Never make a pivot turn at high speed.

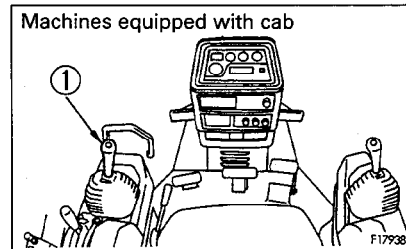

12.7.1 NORMAL TURNING (D65E, P)

To turn the machine while traveling, incline steering and directional lever ① in the direction to turn.

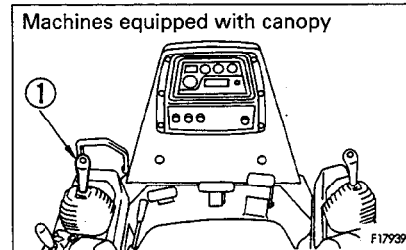

- Turning gradually to left while traveling forward
If the steering and directional lever is pushed forward and moved partially to the left (L), the steering clutch is disengaged and the machine turns gradually to the left.

REMARK

When turning gradually to the right, push the steering and directional lever forward, and move it partially to the right.

Do the same when traveling in reverse.

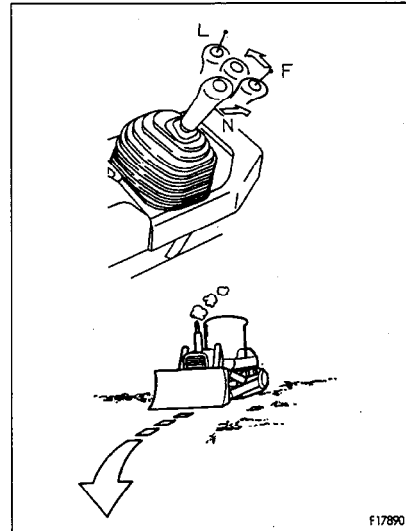

- Making sharp turns to left while traveling forward
If the steering and directional lever is pushed forward and moved fully to the left (L), the steering clutch is disengaged, the brake is applied, and the machine turns sharply to the left.

REMARK

When making sharp turns to the right, push the steering and directional lever forward, and move it fully to the right.

Do the same when traveling in reverse.

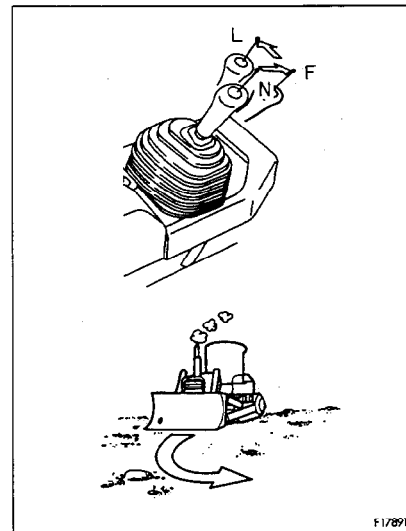

12.7.2 TURNING WHILE DESCENDING A SLOPE (D65E, P)

On steep downhill slopes where the machine may travel under its own weight, or on downhill slopes where it is being pushed by a towed machine, the machine will steer in the opposite direction, so do as follows.

- Turning gradually to left while traveling forward
If the steering and directional lever is pushed forward and moved partially to the right (R), the machine turns gradually to the left. (Becomes reverse steering)

REMARK

When turning gradually to the right, push the steering and directional lever forward, and move it partially to the left. (Becomes reverse steering)

Do the same when traveling in reverse.

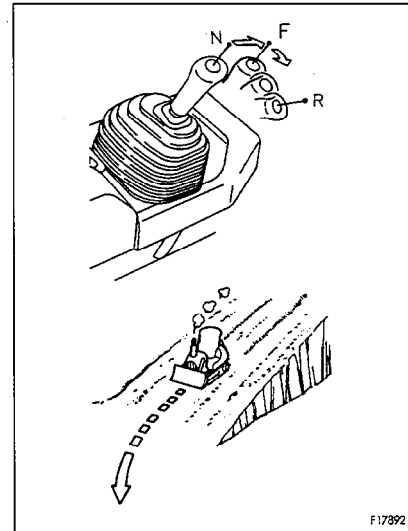

F17892

- Making sharp turns to left while traveling forward
If the steering and directional lever is pushed forward and moved fully to the left (L), the machine turns sharply to the left. (Does not become reverse steering)

REMARK

When making sharp turns to the right, push the steering and directional lever forward, and move it fully to the right. (Does not become reverse steering)

Do the same when traveling in reverse.

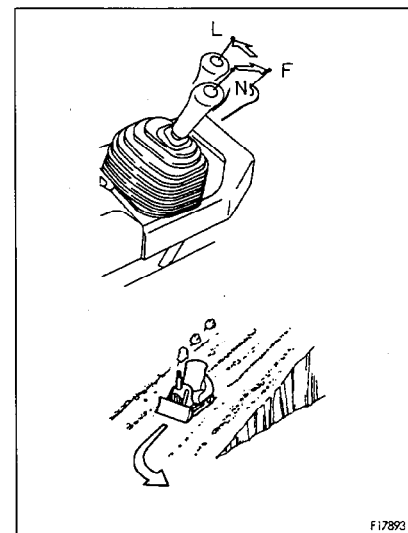

F17893

12.7.3 NORMAL TURNING (D65EX, PX)

⚠ WARNING

The feeling of the operation if the operator carries out a counterrotation turn when your head is facing the rear is different from the feeling when facing the front, so never carry out counterrotation turns when facing the rear.

To turn the machine while traveling, incline steering and directional lever ① in the direction to turn.

- Turnig to left while traveling forward

NOTICE

If the lever is operated partially to the forward or reverse position and then is operated in the direction of turn, the machine may carry out a counterrotation turn, so operate the lever fully to the forward or reverse position.

If the steering and directional lever is pushed forward and moved partially to the left (L), the machine will start to turn gradually. After that, the lever can be moved further toward the end of its stroke to give the desired turning radius.

REMARK

If the steering and directional lever is pushed forward and moved partially to the right, the machine will start to turn gradually to the right. After that, the lever can be moved further toward the end of its stroke to give the desired turning radius.

- Carrying out counterrotation turn to left

NOTICE

When carrying out a counterrotation turn, if the load is not equal on the left and right sides, the machine may carry out a pivot, so check the ground conditions and be careful not to hit any obstacles.

If the steering and directional lever is placed at the N position and is operated partially to the left, the left and right tracks will rotate in opposite directions and the machine will carry out a counterrotation turn smoothly. If the lever is operated fully, the speed of the counterrotation turn will increase.

REMARK

- When carrying out a counterrotation turn to the right, move the steering and directional lever to the right in the same way.
- Depending on the ground conditions, both tracks may move in the opposite direction, or one track may remain locked and the machine may carry out a sharp turn.

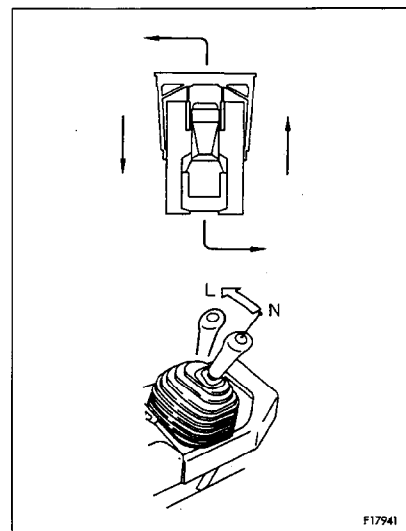
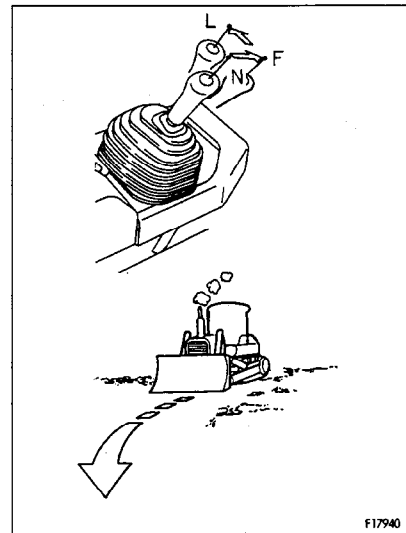
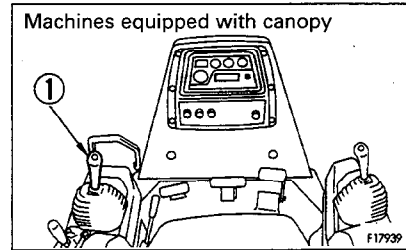
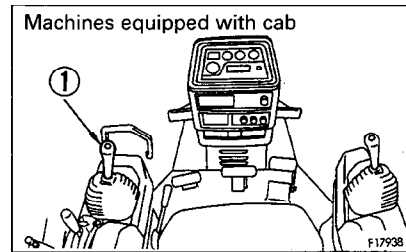

12.7.4 TURNING WHILE DESCENDING A SLOPE (D65EX, PX)

With machines that can carry out counterrotation turns, on steep downhill slopes where the machine may travel under its own weight, or on downhill slopes where it is being pushed by a towed machine, the machine will not steer in the opposite direction, so do as follows.

- Making gradual turns to left while traveling forward
If the steering and directional lever is pushed forward and moved partially to the left (L), the machine turns gradually to the left. (Does not become reverse steering)

REMARK

When making gradual turns to the right, push the steering and directional lever forward, and move it partially to the right. (Does not become reverse steering)

Do the same when traveling in reverse.

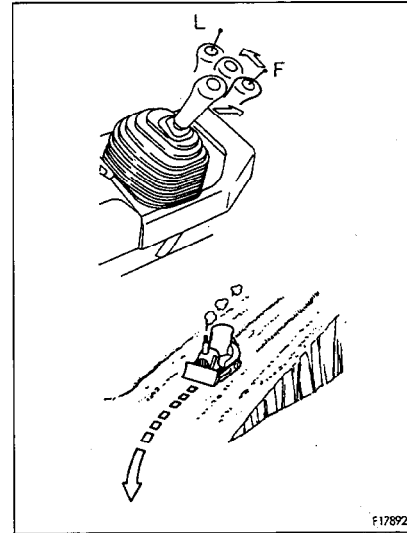

F17892

- Making sharp turns to left while traveling forward
If the steering and directional lever is pushed forward and moved fully to the left (L), the machine turns sharply to the left. (Does not become reverse steering)

REMARK

When making sharp turns to the right, push the steering and directional lever forward, and move it fully to the right. (Does not become reverse steering)

Do the same when traveling in reverse.

NOTICE

Do not use the counterrotation turn on slopes. The load on the left and right sides will not be uniform, and the machine may turn sharply to one side.

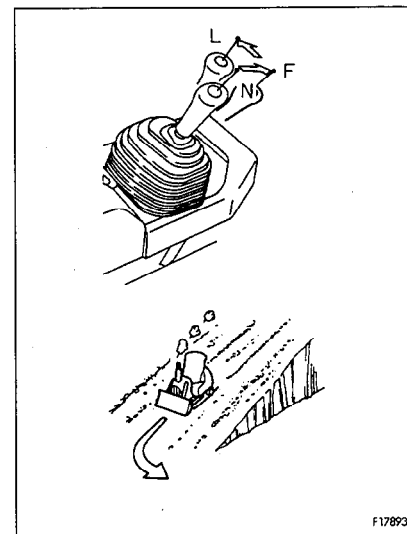

F17893

12.8 STOPPING MACHINE

WARNING

- Avoid stopping suddenly. Give yourself ample room when stopping.
- When stopping the machine, select flat hard ground and avoid dangerous places. If it is unavoidably necessary to park the machine on a slope, place the parking lever in the LOCK position and insert blocks underneath the track shoes. As an additional safety measure, thrust the blade into the ground.
- If the blade control lever is touched by accident, the work equipment may move suddenly, and this may lead to a serious accident. Before leaving the operator's seat, always operate the safety lever to place it securely at the LOCK position.

1. Depress brake pedal ① to stop the machine.

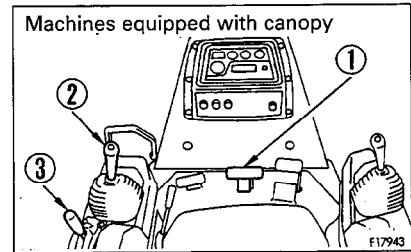
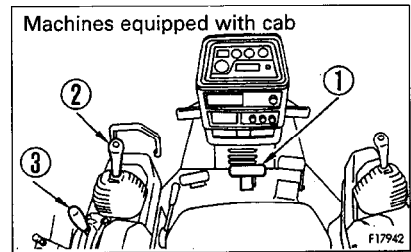

2. Place steering and directional lever ② in the N (neutral) position.

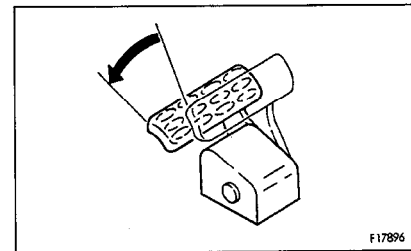

3. Place gear shift lever ③ in the 1st speed position.

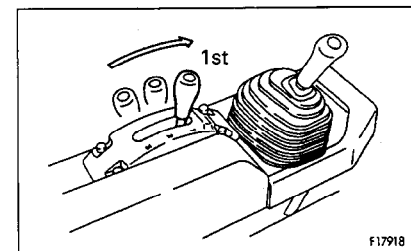
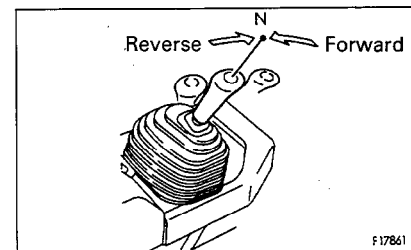

12.9 PRECAUTIONS FOR OPERATION

12.9.1 METHOD OF USING STEERING CLUTCH (D65E, P ONLY)

If the steering clutch one side is used frequently or if many gradual turns are made with steering clutch half-engaged, the steering clutch will wear out in a short time. Design the travel road well and steer the machine properly.

12.9.2 PERMISSIBLE WATER DEPTH

When operating in water, always keep the bottom of carrier roller ① above the surface of the water.

Also, be careful that the engine cooling fan will not come in contact with water. The fan can be damaged.

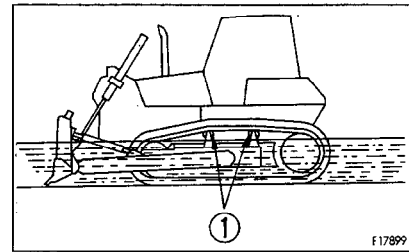

12.9.3 PRECAUTIONS WHEN TRAVELING UP OR DOWN HILLS

Use engine as a brake

When going downhill, shift gear shift lever into low speed to run engine at slow speed and travel down slope using the engine as a brake.

Never coast down slope with the steering and directional lever in the N (neutral) position.

Braking when traveling downhill

While descending a slope using the engine as a brake, also apply the brakes.

Failure to brake may result in overrunning, causing engine trouble.

12.9.4 PRECAUTIONS ON SLOPES

Be careful of fuel level

If the fuel level in the fuel tank becomes low when working on slopes, the engine may suck in air because of the angle of the machine or the swaying of the machine. If this makes the engine stop, so be careful not to let the fuel level in the fuel tank become too low.

Precautions when engine stops on slopes

If the engine stops while working or traveling on a hill, the brake is automatically applied, move the parking lever to the LOCK position to apply the parking brake.

12.9.5 IT IS PROHIBITED TO KEEP THE DOOR OPEN DURING OPERATIONS (MACHINES EQUIPPED WITH CAB)

Always keep the door closed when traveling or carrying out operations. If the door is left open, there is danger of damage from obstacles or strong vibration.

12.9.6 IT IS PROHIBITED TO MODIFY THE CAB GLASS IN ANY WAY THAT WILL OBSTRUCT THE VIEW (MACHINES EQUIPPED WITH CAB)

- For safety reasons, do not install anything to the cab glass that will obstruct the view.
- Always keep the glass clean to ensure safety during operations.

12.9.7 PRECAUTIONS REGARDING BLIND SPOTS CAUSED BY CAB STAYS

⚠ WARNING

The cab stays create blind spots.

When operating the machine, always be sure to check carefully that there are no obstacles or workers in the surrounding area.

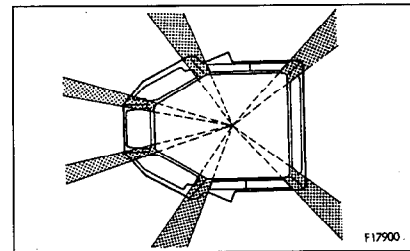

12.10 WORK POSSIBLE USING BULLDOZER

In addition to the following, it is possible to further increase the range of applications by using various attachments.

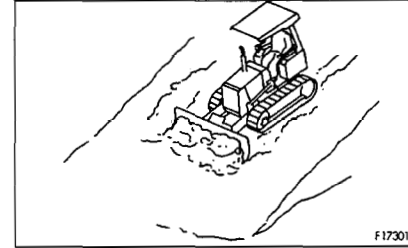

12.10.1 DOZING

A bulldozer digs and transports dirt in a forward direction. Slope excavation can always be most effectively carried out by proceeding from the top downward.

When dozing toward one side only, operate with angled blade (angledozer only).

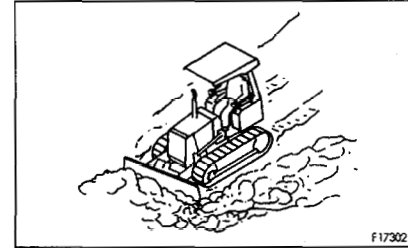

12.10.2 SMOOTHING

NOTICE

Avoid smoothing on rocky or stony ground. It can damage the blade.

Uneven ground surfaces remaining after digging can be levelled off by fine operation of blade. The basic method is to operate the machine at low speeds with the blade fully loaded with soil and sand. A flat finished surface is also possible by slowly backing the machine with the blade "floating" so it is dragged across the surface. However, avoid this on rocky or stony ground, as it may damage the blade.

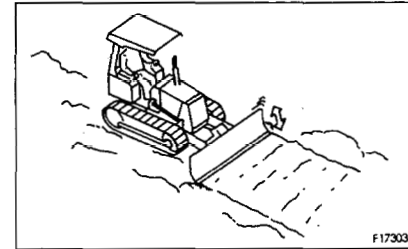

12.10.3 CUTTING INTO HARD OR FROZEN GROUND OR DITCHING

For digging and ditch excavation of hard or frozen ground, tilt the blade. Even hard ground can be dug effectively by a tilted or angled blade.

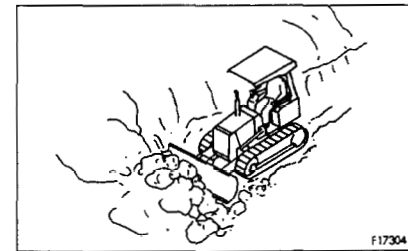

12.10.4 FELLING TREES, REMOVING STUMPS

NOTICE

Do not up root trees or stumps or fell trees by angling or tilting the blade.

For trees with a diameter of 10 – 30 cm, raise the blade high and push 2 or 3 times to fell the tree. Next, travel in reverse, and dig the corner of the blade into the ground to cut and dig up the roots. When doing this, never hit the tree at high speed or apply shock to fell the tree.

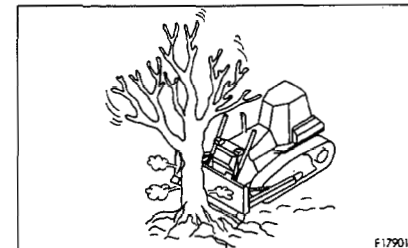

12.11 ADJUSTING POSTURE OF WORK EQUIPMENT

12.11.1 METHOD OF ANGLING BLADE (ANGLEDZER ONLY)

Angle the blade when it is needed to dump the soil on one side.

⚠ WARNING

- When adjusting the amount of angling, it is dangerous if the work equipment is moved by mistake. Set the work equipment in a safe condition, then stop the engine and lock the work equipment securely with the safety lever.
- Be careful when removing arm ①. After arm ① is removed the blade can move freely.

1. Raise the blade 400 – 500 mm above the ground, then put blocks under the frame so that the blade does not come down.

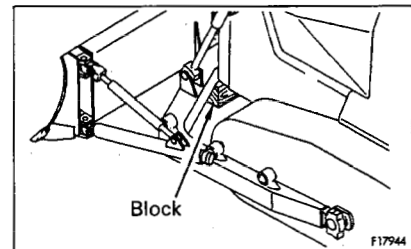

2. Remove pins ① on the left and right sides, then remove arm ② from the frame.

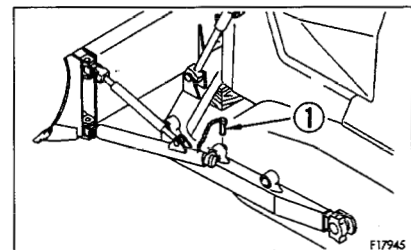

3. Insert arm ② into the desired position on the bracket on top of the frame (3 places on each side), and insert pin ①.

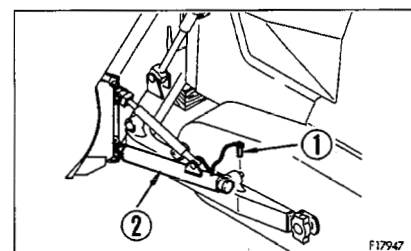
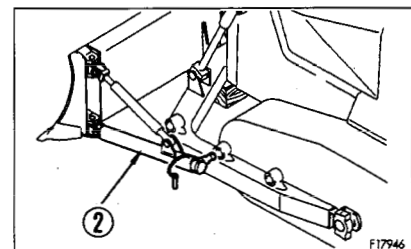

12.11.2 ADJUSTING AMOUNT OF TILT (ANGLEDZER ONLY)

⚠ WARNING

When adjusting the amount of tilt, it is dangerous if the work equipment is moved by mistake. Set the work equipment in a safe condition, then stop the engine and lock the work equipment securely with the safety lever.

NOTICE

The maximum amount of tilt is 400 mm.
Be sure not to exceed 400 mm for the tilt.

1. Raise the blade 400 — 500 mm above the ground, then put blocks under the frame so that the blade does not come down.

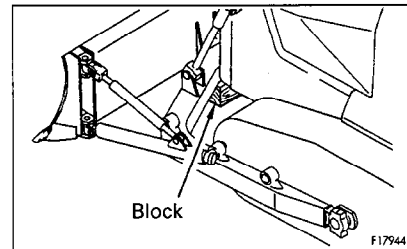

2. Loosen set bolt ① of the brace, insert a suitable bar into hole ② of the brace, and turn it.
Right tilt: Make right side shorter, left side longer
Left tilt: Make left side shorter, right side longer
3. Tighten set bolt ①.

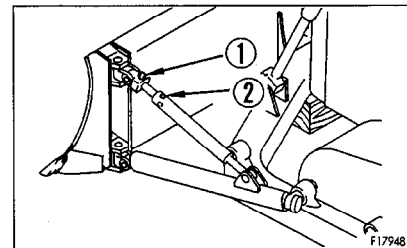

12.11.3 ADJUST ANGLE OF BLADE EDGE

WARNING

It is dangerous if the work equipment moves by mistake when adjusting angle of the blade edge. Set the work equipment in a stable condition, then stop the engine and apply the locks securely to the safety lever.

Adjust the angle (θ) of the blade edge to match the type of soil.

- **Angledozer**

Adjust the cutting angle by changing the distance (ℓ) between the joints so that the length of the brace is the same on the left and right sides.

INCREASE distance (ℓ) to INCREASE angle (θ).

DECREASE distance (ℓ) to DECREASE angle (θ).

The standard for the cutting angle (θ) is 55°.

The standard for the distance (ℓ) between the joints is 1127 mm.

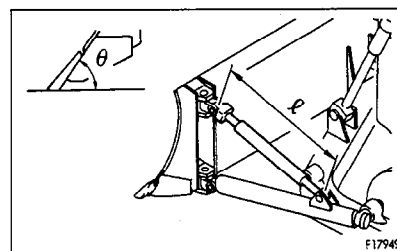

- **Power tilt dozer**

Turn the brace with bar handle ① and adjust the distance (ℓ) between the joints to change the cutting angle (θ) as follows.

INCREASE distance (ℓ) to INCREASE angle (θ).

DECREASE distance (ℓ) to DECREASE angle (θ).

The standard for the cutting angle (θ) is 55°.

The standard for the distance (ℓ) between the joints is 1150 mm.

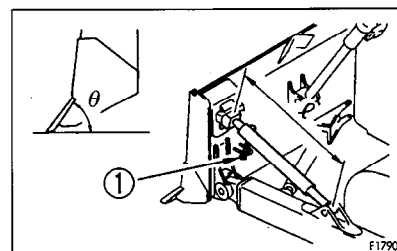

12.12 PARKING MACHINE

WARNING

- Avoid stopping suddenly. Give yourself ample room when stopping.
- When stopping the machine, select flat hard ground and avoid dangerous places. If it is unavoidably necessary to park the machine on a slope, place the parking lever in the LOCK position and insert blocks underneath the track shoes. As an additional safety measure, thrust the blade into the ground.
- If the blade control lever is touched by accident, the work equipment may move suddenly, and this may lead to a serious accident. Before leaving the operator's seat, always operate the safety lever to place it securely at the LOCK position.

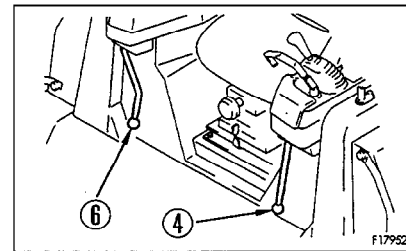
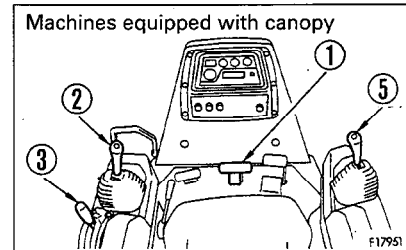
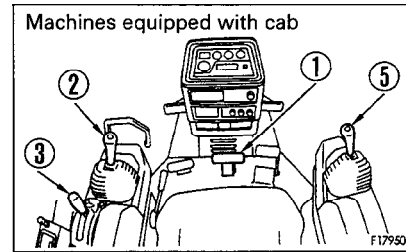

1. Depress brake pedal ① to stop the machine.

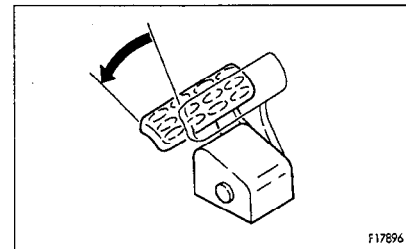

2. Place steering and directional lever ② in NEUTRAL position.

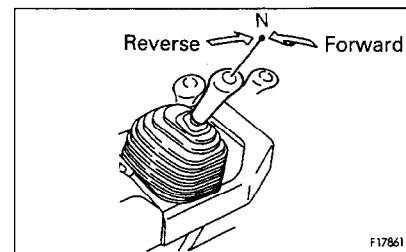

3. Place gear shift lever ③ in the 1st speed position.

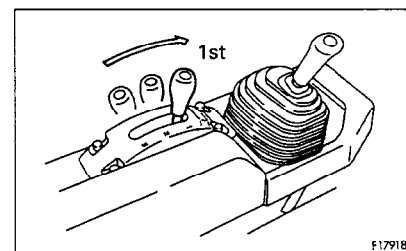

- Operate parking lever ④ to lock the brakes.

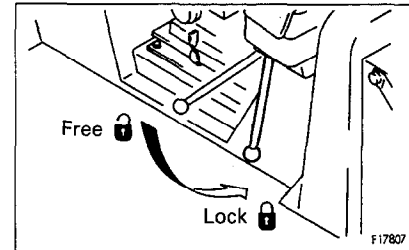

- Put blade control lever ⑤ in the LOWER position to lower the blade to the ground while keeping it horizontal.

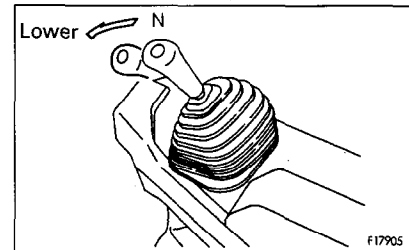

- Lock blade control lever ⑤ with safety lever ⑥.

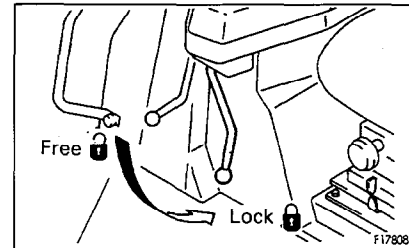

12.13 CHECK AFTER FINISHING WORK

- Check the gauges and caution lamps for engine water temperature, engine oil pressure, fuel level and transmission oil temperature.

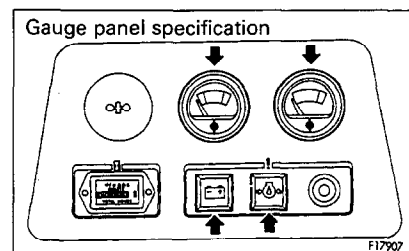
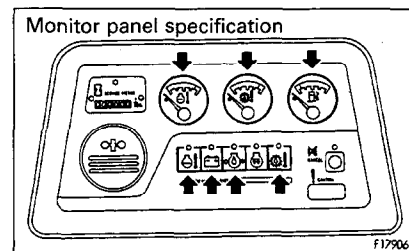

12.14 STOPPING ENGINE

NOTICE

If the engine is abruptly stopped before it has cooled down, engine life may be greatly shortened. Consequently, do not abruptly stop the engine apart from an emergency.

In particular, if the engine has overheated, do not abruptly stop it but run it at medium speed to allow it to cool gradually, then stop it.

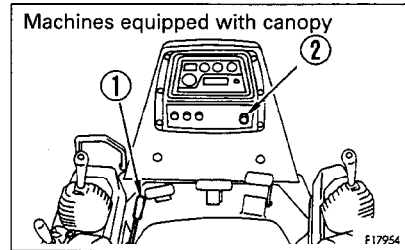
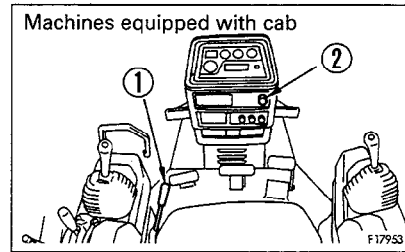

1. Place fuel control lever in the low idling position and run the engine at low idling speed for about 5 minutes to allow it to gradually cool down.

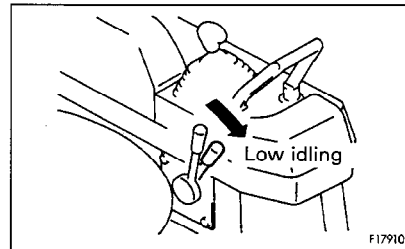

2. Place fuel control lever ① in the engine stop position and stop the engine.

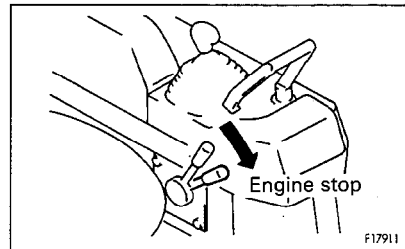

3. Turn the key in starting switch ② to the OFF position and remove the key from starting switch ②.

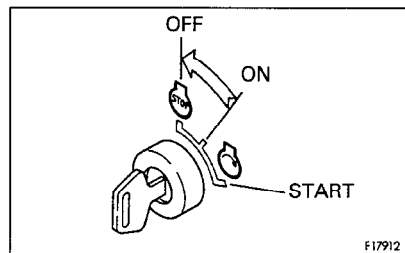

12.15 CHECK AFTER STOPPING ENGINE

1. Walk around the machine and check the work equipment, paintwork, and undercarriage, and check also for leakage of oil or water. If any abnormalities are found, repair them.
2. Fill the fuel tank.
3. Check the engine compartment for paper and debris. Clean out any paper and debris to avoid a fire hazard.
4. Remove any mud stuck to the undercarriage.

12.16 LOCKING

To prevent vandalism, there are locks at the following places.

Places that can be locked with the starting switch key.

- Top cover at front of chassis ①
- Right and left engine side cover ②
- Battery inspection cover ③
- Inspection cover for fuel tank drain valve ④
- Cab door opener ⑤ (machines equipped with cab)
- Cap with lock ⑥

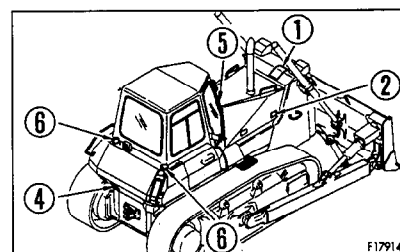
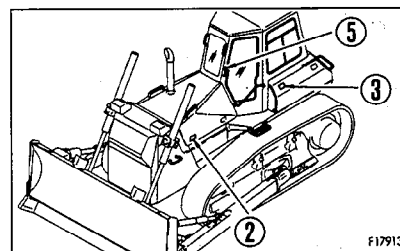

12.17 TIPS FOR LONGER UNDERCARRIAGE LIFE

Undercarriage life greatly varies depending on operation method, inspection and maintenance. For most efficient operation, keep the following point in mind.

12.17.1 OPERATION METHOD

- Select the track shoe that best suits the type of soil to be encountered in service.
Please consult your Komatsu distributor when selecting track shoes.
- Do not allow shoe slipping to occur during operation. If shoe slipping occurs, reduce load to the blade until slipping stops.
- Avoid sudden starts, acceleration or stops, unnecessarily high speeds and sharp turns.
- Always operate machine in a straight line whenever possible. When making turns, be careful not to allow the machine to stay to one side, so operation in both turning directions can be done properly. Make turns with the largest possible radius.
- Prior to operation, clear boulders and obstacles to prevent machine from riding over them while operating.
- On a slope, operate the machine parallel to the inclination of the slope. Do not operate across the slope. Also when stopping the machine on a slope, the machine should face toward the top of the slope.

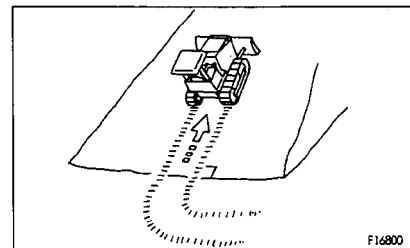

- When ground inclines to left or right during digging operation, do not continue to dig with machine inclined. Move machine back to level ground and start to dig again.
- Do not force the machine to carry out work that exceeds its working capability. Such work includes cases where the idler or sprocket come off the ground when the machine meets obstacles that resist the power of the machine during dozing or ripping operations.

12.17.2 INSPECTION AND ADJUSTMENT

- Properly adjust track tension.
Tension should be measured at clearance ① shown in the diagram — usually 20 to 30 mm at this point. For rocky terrain, tighten tracks slightly. In clay or sandy areas, slightly loosen them. (For inspection and adjustment procedures, refer to "24.1 WHEN REQUIRED").
- Check idler rollers for oil leakage as well as for loose bolts and nuts. If any trouble is detected, repair immediately.
- Check the clearance between the idler guide plate and the track frame. If clearance ② increases, idler may develop side motion and tracks may come off. (For inspection and adjustment procedures, refer to "24.1 WHEN REQUIRED".)

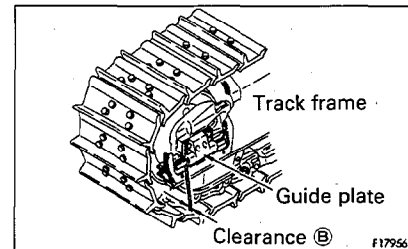
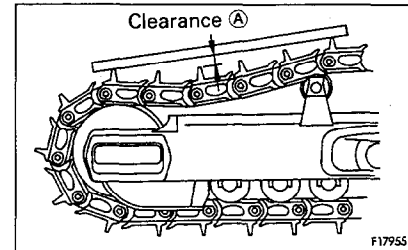

12.17.3 INSPECTION AND REPAIR

Frequent inspection and prompt repair will reduce repair costs. The following items for inspection will serve as a guide to maintenance service of each undercarriage part. Perform periodical inspection and contact the Komatsu distributor in your area when machine has approached repairable limits and reversing limits.

Measuring link pitch

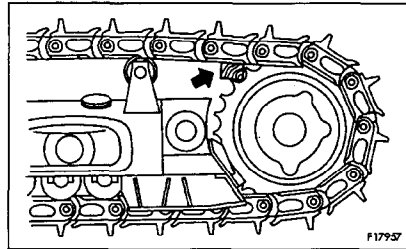
1. Insert a wooden block between track shoe and sprocket to take up the slack in track shoes.
- 
- A technical drawing of a track shoe on a sprocket. A wooden block is shown inserted between the track shoe and the sprocket teeth. An arrow points to the block. The drawing is identified by the code "F17957" in the bottom right corner.
2. Measure pitch length of 4 links in stretched portion at more than 2 links away from master pin. Of length obtained, 1/4 is the link pitch.
Standard link pitch (P): 203 mm
Reversing limit link pitch: 206 mm
There is no link window on the master link.

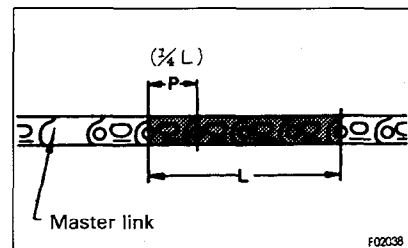

Measuring height of grouser (D65E, EX)

After taking up slack in track shoes, measure height at center of shoe as shown below.

Standard height (h): 65 mm

Repair limits: 25 mm

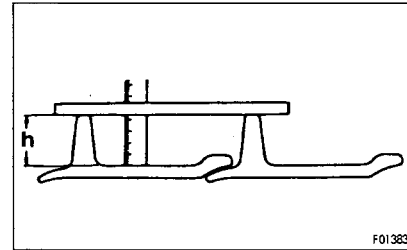

Measuring outside diameter of track roller

1. Measure height (size C) of link tread as shown.
2. Stop machine at position where link tread, whose size C has been measured completely, contacts roller tread. Then measure size B.
3. Calculate outside diameter of tread (size A):
 $A = (B - C) \times 2$
Standard size (A): 210 mm
Repair limits: 172 mm

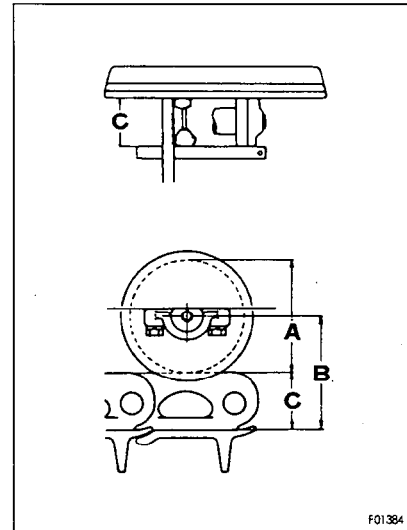

13. TRANSPORTATION

When transporting the machine, observe all related laws and regulations, and be careful to assure safety.

13.1 LOADING, UNLOADING WORK

⚠ WARNING

- Make sure the ramp has sufficient width, length and thickness to enable the machine to be safely loaded and unloaded. If the ramp sags appreciably, reinforce it with blocks, etc.
- When loading and unloading the machine, park the trailer on a flat firm roadbed. Keep a fairly long distance between the road shoulder and the machine.
- Remove the mud from the undercarriage to prevent the machine from slipping to the side on slopes. Be sure the ramp surface is clean and free of grease, oil, ice and loose materials.
- Never change the direction of travel when on the ramps. If it is necessary to change direction, drive off the ramps and correct the direction, then drive on to the ramps again.
- Do not use the counterrotation turn. (D65EX, PX)

When loading or unloading, always use ramps or a platform and carry out the operations as follows.

1. Properly apply the brakes on the trailer and insert blocks beneath the tires to ensure that it does not move. Then fix the ramps in line with the centers of the trailer and the machine.
2. Determine the direction of the ramps, then slowly load or unload the machine.
3. Load the machine correctly in the specified position on the trailer.

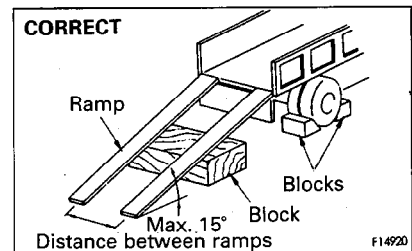

13.2 PRECAUTIONS FOR LOADING

 **WARNING**

When the edge of the blade protrudes beyond the trailer, angle the blade. (Angledozer)

After loading to the specified position, secure the machine as follows.

1. Lower the blade slowly.
2. Lock all the control levers securely with the safety lever.
3. Set the parking lever to the LOCK position.
4. Set the fuel control lever to the ENGINE STOP position to stop the engine, then turn the starting switch to the OFF position and remove the key.
5. When transporting the machine, place rectangular timber underneath the front and rear track shoes to prevent the machine from moving about. Also, hold it down with chains or rope. Be particularly careful to ensure that the machine does not slip sideways.

13.3 PRECAUTIONS FOR TRANSPORTATION

 **WARNING**

Determine the route for transporting the machine by taking into account the width, height and weight of the machine.

Obey all state and local laws governing the weight, width and length of a load. Observe all regulations governing wide loads.

13.4 PRECAUTIONS WHEN REMOVING WORK EQUIPMENT

If there is any pressure remaining in the tilt piping after the work equipment has been removed, it may be difficult to remove the quick coupler of the tilt hose, so remove the work equipment as follows.

1. Lower the blade to the ground and set it horizontal to the ground surface.

REMARK

If the blade is tilted, the tilt piping will be under internal pressure, so set the blade horizontal to the ground.

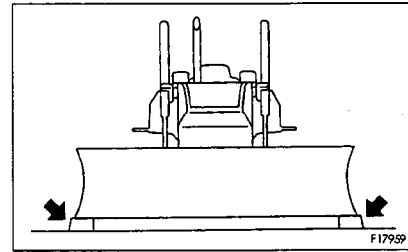

2. Remove the quick coupler, then remove the work equipment assembly.

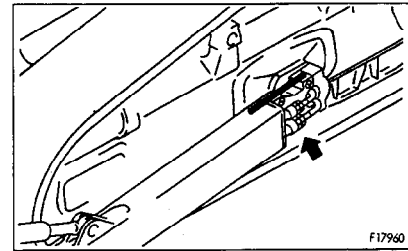

13.5 REMOVING CAB (MACHINES EQUIPPED WITH CAB)

If it is necessary to remove the cab for transportation, there is danger that the seal may be damaged when removing or installing the cab, so please contact your Komatsu distributor.

14. COLD WEATHER OPERATION

14.1 PRECAUTIONS FOR LOW TEMPERATURE

If the temperature becomes low, it becomes difficult to start the engine, and the coolant may freeze, so do as follows.

14.1.1 FUEL AND LUBRICANTS

Change to fuel and oil with low viscosity for all components. For details of the specified viscosity, see "20. USE OF FUEL, COOLANT AND LUBRICANTS ACCORDING TO AMBIENT TEMPERATURE".

14.1.2 COOLANT



WARNING

Keep antifreeze fluid away from an open flame. Never smoke when using antifreeze.

NOTICE

Never use methanol, ethanol or propanol based antifreeze.

Where no permanent antifreeze is available, an ethylene glycol antifreeze without corrosion inhibitor may be used only for the cold season. In this case, clean the cooling system twice a year (in spring and autumn). When refilling the cooling system, add antifreeze in autumn, but do not add any in spring.

Absolutely avoid using any water leak preventing agent irrespective of whether it is used independently or mixed with an antifreeze.

Do not mix one antifreeze with a different brand.

For details of the antifreeze mixture when changing the coolant, see "24.1 WHEN REQUIRED".

Use a Permanent Antifreeze (ethylene glycol mixed with corrosion inhibitor, antifoam agent, etc.) meeting the standard requirements as shown below. With permanent antifreeze, no change of coolant is required for a year. If it is doubtful that an available antifreeze meets the standard requirements, ask the supplier of that antifreeze for information.

Standard requirements for permanent antifreeze.

- SAE J1034
- FEDERAL STANDARD O-A-548D

14.1.3 BATTERY

⚠ WARNING

- To avoid gas explosions, do not bring fire or sparks near the battery.
- Battery electrolyte is dangerous. If it gets in your eyes or on your skin, wash it off with large amounts of water, and consult a doctor.

When the ambient temperature drops, the capacity of the battery will also drop. If the battery charge ratio is low, the battery electrolyte may freeze. Maintain the battery charge as close as possible to 100%, and insulate it against cold temperature so that the machine can be started easily the next morning.

Measure the specific gravity and calculate the rate of charge from the following conversion table.

Temp. of fluid Rate of charge	20°C	0°C	-10°C	-20°C
100%	1.28	1.29	1.30	1.31
90%	1.26	1.27	1.28	1.29
80%	1.24	1.25	1.26	1.27
75%	1.23	1.24	1.25	1.26

14.2 AFTER COMPLETION OF WORK

To prevent mud, water, or the undercarriage from freezing and making it impossible for the machine to move on the following morning, always observe the following precautions.

- Mud and water on the machine body should be completely removed. This is to prevent damage to the seal caused by mud or dirt getting inside the seal with frozen drops of water.
- Park the machine on concrete or hard ground. If this is impossible, park the machine on wooden boards.
- Open the drain valve and drain any water collected in the fuel system to prevent it from freezing.
- As the battery capacity drops markedly in low temperatures, cover the battery or remove it from the machine, keep it in a warm place, and install it again the next morning.

14.3 AFTER COLD WEATHER

When season changes and the weather becomes warmer, do as follows.

- Replace the fuel and oil for all parts with oil of the viscosity specified.
For details, see "20. USE OF FUEL, COOLANT AND LUBRICANTS ACCORDING TO AMBIENT TEMPERATURE".
- If for any reason permanent antifreeze cannot be used, and an ethyl glycol base antifreeze (winter, one season type) is used instead, or if no antifreeze is used, drain the cooling system completely, then clean out the inside of the cooling system thoroughly, and fill with fresh water.

15. LONG-TERM STORAGE (MORE THAN ONE MONTH)

15.1 BEFORE STORAGE

 WARNING

If possible, prepare the machine for long-term storage outdoors. If this must be done indoors, open doors and windows for ventilation to prevent carbon monoxide poisoning.

When putting the machine in storage for more than one month, do as follows.

- After every part is washed and dried, the machine shall be housed in a dry building. Never leave it outdoors.
In case it is indispensable to leave it outdoors, park the machine on the flat ground and cover it with canvas etc.
- Completely fill the fuel tank, lubricate and change the oil before storage.
- Apply a thin coat of grease to metal surface of the hydraulic piston rods and the idler adjusting rods.
- Disconnect the negative terminals of the battery and cover it, or remove it from the machine and store it separately.
- If the ambient temperature is expected to drop below 0°C, always add antifreeze to the cooling water.
- Place all control levers at the neutral position, operate the safety lever and parking lever to the LOCK position, then move the fuel control lever to the low idling position.

15.2 DURING STORAGE

- Operate the engine and move the machine for a short distance once a month so that a new film of oil will be coated over movable parts and component surfaces. At the same time, also charge the battery.
- Before operating the work equipment, wipe off the grease on the hydraulic piston rod.

15.3 AFTER STORAGE

NOTICE

If the machine is stored without carrying out the monthly rust prevention operation, request your Komatsu distributor for service.

Carry out the following procedure when taking the machine out of long-term storage.

- Wipe off the grease from the hydraulic cylinder rods.
- Add oil and grease to all places.

16. TROUBLESHOOTING

16.1 AFTER RUNNING OUT OF FUEL

When starting after running out of fuel, fill with fuel and bleed the air from the fuel system before starting.

For details of bleeding the air, see "24.5 EVERY 500 HOURS SERVICE".

16.2 IF BATTERY IS DISCHARGED

WARNING

- When checking or handling the battery, stop the engine and turn the starting key to the OFF position before starting.
- The battery generates hydrogen gas, so there is danger of explosion. Do not bring lighted cigarettes near the battery, or do anything that will cause sparks.
- Battery electrolyte is dilute sulphuric acid, and it will attack your clothes and skin. If it gets on your clothes or on your skin, wash it immediately off with large amounts of water. If it gets in your eyes, wash it out with fresh water, and consult a doctor.
- When removing the battery, first disconnect the cable from the ground (normally, from the negative \ominus terminal). When installing, install the positive \oplus terminal first. If a tool touches the cable connecting the positive terminal and the chassis, there is danger that it will cause sparks.
- If the terminals are loose, there is danger that the defective contact may generate sparks that will cause an explosion. When installing the terminals, install them tightly.

16.2.1 STARTING ENGINE WITH BOOSTER CABLE

When starting the engine with a booster cable, do as follows:

When removing, disconnect the cable from the ground terminal first.

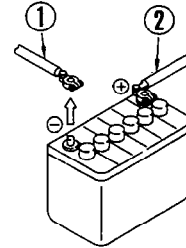

When installing, connect the cable to the positive \oplus terminal first.

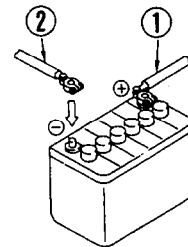

F16801

REMOVAL, INSTALLATION OF BATTERY

1. Open battery cover ①, remove 4 bolts ② on the inside, then remove cover ①.
2. Before removing the battery, remove the ground cable (normally connected to the negative \ominus terminal). If any tool touches between the positive terminal and the chassis, there is danger of sparks being generated. Loosen the nut of the terminal and remove the wires from the battery.
3. When installing the battery, connect the ground cable last. Insert the hole of the terminal on the battery and tighten the nut.
Tightening torque: 0.6 – 1.0 kgm
4. Install battery cover ①.

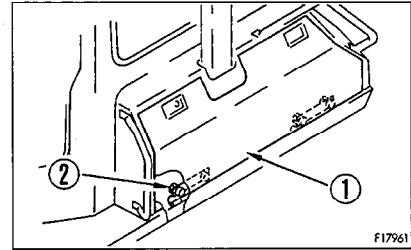

Precautions when connecting and disconnecting booster cable

⚠ WARNING

- When starting the engine from another machine, connect the batteries in parallel.
- When connecting the cables, never contact the positive \oplus and negative \ominus terminals.
- When starting the engine with a booster cable, always wear safety glasses.
- Be careful not to let the normal machine and problem machine contact each other. This prevents sparks from generating near the battery which could ignite the hydrogen gas given off by the battery. If hydrogen gas explodes. It could cause serious injury.
- Make sure that there is no mistake in the booster cable connections. The final connection is to the engine block of the problem machine, but sparks will be generated when this is done, so connect to a place as far as possible from the battery.
- Use care when removing the cables from the machine that has been started. Do not allow the cable ends to contact each other or the machine, to avoid hydrogen explosion.

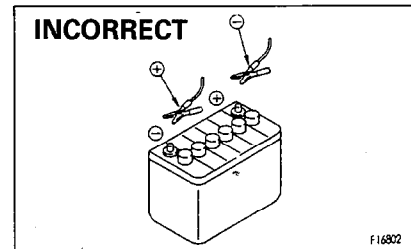

NOTICE

- The size of the booster cable and clip should be suitable for the battery size.
- The battery of the normal machine must be the same capacity as that of the engine to be started.
- Check the cables and clips for damage or corrosion.
- Make sure that the cables and clips are firmly connected.

Connecting the booster cables

Keep the starting switch at the OFF position.

Connect the booster cable as follows, in the order of the numbers marked in the diagram.

1. Make sure that the starting switches of the normal machine and problem machine are both at the OFF position.
2. Connect one clip of booster cable (A) to the positive \oplus terminal of the problem machine.
3. Connect the other clip of booster cable (A) to the positive \oplus terminal of the normal machine.
4. Connect one clip of booster cable (B) to the negative \ominus terminal of the normal machine.
5. Connect the other clip of booster cable (B) to the engine block of the problem machine.

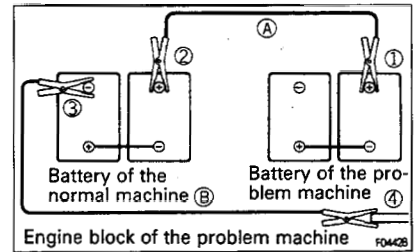

Starting the engine

1. Make sure the clips are firmly connected to the battery terminals.
2. Start the engine of the normal machine and keep it to run at high idling speed.
3. Turn the starting switch of the problem machine to the START position and start the engine. Refer to "12.2 STARTING ENGINE".

Disconnecting the booster cables

After the engine has started, disconnect the booster cables in the reverse of the order in which they were connected.

1. Remove one clip of booster cable (B) from the engine block of the problem machine.
2. Remove the other clip of booster cable (B) from the negative \ominus terminal of the normal machine.
3. Remove one clip of booster cable (A) from the positive \oplus terminal of the normal machine.
4. Remove the other clip of booster cable (A) from the positive \oplus terminal of the problem machine.

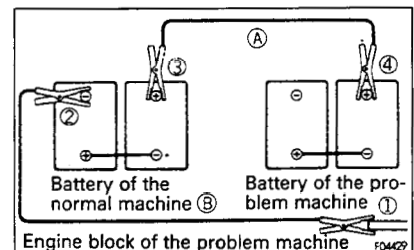

16.3 OTHER TROUBLE

- (): Always contact your Komatsu distributor when dealing with these items.
- In cases of abnormalities or causes which are not listed below, please contact your Komatsu distributor for repairs.

16.3.1 ELECTRICAL SYSTEM

Problem	Main causes	Remedy
Lamp does not glow brightly even when the engine runs at high speed	<ul style="list-style-type: none"> • Defective wiring • Defective adjustment of fan belt tension 	<ul style="list-style-type: none"> • Check, repair loose terminals, disconnections • Adjust fan belt tension For details, see EVERY 250 HOURS SERVICE
Lamp flickers while engine is running		
Charge lamp does not go out even when engine is running	<ul style="list-style-type: none"> • Defective alternator • Defective wiring 	<ul style="list-style-type: none"> • Replace • Check, repair
Abnormal noise is generated from alternator	<ul style="list-style-type: none"> • Defective alternator 	<ul style="list-style-type: none"> • Replace
Starting motor does not turn when starting switch is turned to ON	<ul style="list-style-type: none"> • Defective wiring • Insufficient battery charge • Safety switch out of adjust 	<ul style="list-style-type: none"> • Check, repair • Charge • Adjust safety switch
Pinion of starting motor keeps going in and out	<ul style="list-style-type: none"> • Insufficient battery charge 	<ul style="list-style-type: none"> • Charge
Starting motor turns engine sluggishly	<ul style="list-style-type: none"> • Insufficient battery charge • Defective starting motor 	<ul style="list-style-type: none"> • Charge • Replace
Starting motor disengages before engine starts	<ul style="list-style-type: none"> • Defective wiring • Insufficient battery charge 	<ul style="list-style-type: none"> • Check, repair • Charge
Automatic preheating is not actuated	<ul style="list-style-type: none"> • Defective wiring • Defective glow heater • Defective timer 	<ul style="list-style-type: none"> • Check, repair • Replace • Replace
Glow signal lamp does not go out (monitor panel specification only)	<ul style="list-style-type: none"> • Defective wiring • Defective heater relay 	<ul style="list-style-type: none"> • Check, repair • Replace
Glow signal does not glow red (gauge panel specification only)	<ul style="list-style-type: none"> • Defective wiring • Defective heater relay • Defective glow signal 	<ul style="list-style-type: none"> • Check, repair • Replace • Replace
Oil pressure caution lamp does not light up when engine is stopped (starting switch at ON position)	<ul style="list-style-type: none"> • Defective caution lamp • Defective caution lamp switch • Defective wiring 	<ul style="list-style-type: none"> • Replace • Replace • Check, repair
Charge lamp does not light up when engine is stopped (starting switch at ON position)	<ul style="list-style-type: none"> • Defective charge lamp • Defective wiring 	<ul style="list-style-type: none"> • Replace • Check, repair
Outside of electrical intake air heater is not warm when touched by hand	<ul style="list-style-type: none"> • Defective wiring • Disconnection in electrical intake air heater • Defective operation of heater relay switch 	<ul style="list-style-type: none"> • Check, repair • Replace • Check, repair heater relay switch

Problem	Main causes	Remedy
Air conditioner does not work properly	<ul style="list-style-type: none">• Blown fuse• Insufficient battery charge• Defective air conditioner switch• Defective blower switch• Defective compressor	<ul style="list-style-type: none">(• Check, repair)• Charge(• Replace air conditioner switch)(• Replace blower switch)(• Replace)
Blade pitch does not change even when pitch operation is carried out (pitch specification machines only)	<ul style="list-style-type: none">• Defective wiring• Defective switch• Defective solenoid valve	<ul style="list-style-type: none">(• Check, repair)(• Replace)(• Replace)

16.3.2 CHASSIS

Problem	Main causes	Remedy
When brake pedal is depressed, machine does not stop	<ul style="list-style-type: none"> • Brakes out of adjust, defective brake oil pressure 	(• Check, adjust)
Track comes off	<ul style="list-style-type: none"> • Track too loose 	<ul style="list-style-type: none"> • Adjust track tension, see WHEN REQUIRED
Abnormal wear of sprocket	<ul style="list-style-type: none"> • Track too loose or too tightened 	
Blade rises slowly, does not rise	<ul style="list-style-type: none"> • Lack of hydraulic oil 	<ul style="list-style-type: none"> • Add oil to specified level, see EVERY 250 HOURS SERVICE
Does not steer even when steering is operated	<ul style="list-style-type: none"> • Defective hydraulic pressure at steering clutch 	(• Check, repair)
Noise is generated from idler	<ul style="list-style-type: none"> • Lack of oil in idler 	<ul style="list-style-type: none"> • Add oil to specified level. For details, see WHEN REQUIRED.
Transmission oil pressure does not rise	<ul style="list-style-type: none"> • Wear, scuffing of gear pump • Lack of oil in power train case • Element strainer of oil filter in power train case clogged 	<ul style="list-style-type: none"> (• Check, replace) • Add oil to specified level. For details, see CHECKS BEFORE STARTING. • Clean. For details, see EVERY 1000 HOURS SERVICE.
Lacks drawbar pull (cannot travel at full speed)	<ul style="list-style-type: none"> • Lack of drive power from engine 	<ul style="list-style-type: none"> • See ENGINE RELATED PARTS
Machine does not move off when gear shift lever is placed in gear	<ul style="list-style-type: none"> • Lack of oil in power train case • Transmission oil pressure does not rise • Steering clutch is slipping <ul style="list-style-type: none"> ○ Wear, scuffing of gear pump 	<ul style="list-style-type: none"> • Add oil to specified level. For details, see CHECKS BEFORE STARTING. • See "Transmission oil pressure does not rise" above (• Check, replace)
Torque converter overheats (indicator enters red range)	<ul style="list-style-type: none"> • Lack of oil in power train case • Transmission oil pressure does not rise • Steering clutch is slipping <ul style="list-style-type: none"> ○ Wear, scuffing of gear pump • Excessive load when operating 	<ul style="list-style-type: none"> • Add oil to specified level. For details, see CHECKS BEFORE STARTING. • See "Transmission oil pressure does not rise" above (• Check, replace) • Shift down one position, or reduce the load and increase the speed when operating.

16.3.3 ENGINE

Problem	Main causes	Remedy
Engine oil pressure caution lamp remains alight when engine speed is raised after completion of warm-up	<ul style="list-style-type: none"> • Engine oil pan oil level is low (sucking in air) • Clogged oil filter cartridge • Defective tightening of oil pipe joint, oil leakage from damaged part • Defective caution lamp 	<ul style="list-style-type: none"> • Add oil to specified level, see CHECK BEFORE STARTING • Replace cartridge, see EVERY 250 HOURS SERVICE (• Check, repair) (• Replace lamp)
Steam is emitted from top part of radiator (pressure valve)	<ul style="list-style-type: none"> • Cooling water level low, water leakage • Loose fan belt • Dirt or scale accumulated in cooling system • Clogged radiator fin or damaged fin • Defective thermostat • Loose radiator filler cap (high altitude operation) • Defective water temperature gauge 	<ul style="list-style-type: none"> • Add cooling water, repair, see CHECK BEFORE STARTING • Adjust fan belt tension, see EVERY 250 HOURS SERVICE • Change cooling water, clean inside of cooling system, see WHEN REQUIRED • Clean or repair, see WHEN REQUIRED (• Replace thermostat) • Tighten cap or replace packing (• Replace water temperature gauge)
Indicator of water temperature gauge is in red range on right side of gauge	<ul style="list-style-type: none"> • Defective thermostat • Defective water temperature gauge 	<ul style="list-style-type: none"> (• Replace thermostat) (• Replace water temperature gauge)
Indicator of water temperature gauge is in white range on left side of gauge	<ul style="list-style-type: none"> • Defective thermostat • Defective water temperature gauge 	<ul style="list-style-type: none"> (• Replace thermostat) (• Replace water temperature gauge)
Engine does not start when starting motor is turned	<ul style="list-style-type: none"> • Lack of fuel • Air in fuel system • Defective fuel injection pump or nozzle • Starting motor cranks engine sluggishly • Glow signal does not glow red • Defective compression <ul style="list-style-type: none"> ○ Defective valve clearance 	<ul style="list-style-type: none"> • Add fuel, see CHECK BEFORE STARTING • Repair place where air is sucked in (• Replace pump or nozzle) — See ELECTRICAL SYSTEM (○ Adjust valve clearance)
Exhaust gas is white or blue	<ul style="list-style-type: none"> • Too much oil in oil pan • Improper fuel 	<ul style="list-style-type: none"> • Add oil to specified level, see CHECK BEFORE STARTING • Change to specified fuel
Exhaust gas occasionally turns black	<ul style="list-style-type: none"> • Clogged air cleaner element • Defective nozzle • Defective compression 	<ul style="list-style-type: none"> • Clean or replace, see WHEN REQUIRED (• Replace nozzle) (• Adjust valve clearance)
Combustion noise occasionally makes breathing sound	<ul style="list-style-type: none"> • Defective nozzle 	<ul style="list-style-type: none"> (• Replace nozzle)
Abnormal noise generated (combustion or mechanical)	<ul style="list-style-type: none"> • Low grade fuel being used • Overheating • Damage inside muffler • Excessive valve clearance 	<ul style="list-style-type: none"> • Change to specified fuel • See item "Indicator of water temperature gauge is in red range on right side of gauge". (• Replace muffler) (• Adjust valve clearance)

MAINTENANCE



17. GUIDES TO MAINTENANCE

Do not carry out any inspection and maintenance operation that is not given in this manual.

Perform maintenance work on hard, flat ground.

Check service meter

Check the service meter reading every day to see if the time has come for any necessary maintenance to be carried out.

Komatsu genuine replacement parts:

Use Komatsu genuine parts specified in the parts list as replacement parts.

Komatsu genuine oils:

Use Komatsu genuine oils and grease. Choose oils and grease with proper viscosities specified for ambient temperature.

Always use clean washer fluid

Use automobile window washer fluid and be careful not to let any dirt get into it.

Clean oil and grease:

Use clean oil and grease. Also, keep containers of the oil and grease clean. Keep foreign materials away from oil and grease.

Keeping the machine clean:

Always keep the machine clean. This makes it easier to find parts causing problems. Keep in particular grease fittings, breathers and oil level gauges clean and avoid foreign matters from getting in them.

Be careful of hot water and oil:

Draining hot oils and coolants and removing their filters immediately after the engine stops are hazardous. Allow the engine to cool.

If the oil has to be drained when it is cold, warm up the oil to a suitable temperature (approx. 20 – 40°C) before draining it.

Checking foreign materials in drained oil:

After oil is changed or filters are replaced, check the oil and filters for metallic particles and foreign materials. If large quantities of metallic particles or foreign materials are found, consult your Komatsu distributor.

Fuel strainer:

If your machine is equipped with a fuel strainer, do not remove it while fueling.

Oil change:

Check or change oils in the places where dust is scarce to keep foreign materials away from oils.

Warning tag:

Attach the warning tag to the starting switch or other appropriate control lever to avoid someone who is not aware of the circumstances from starting the engine.

Obey precautions:

During the operation, always obey the precautions on the safety label stuck to the machine.

Welding instructions:

- Turn off the engine starting switch.
- Do not apply more than 200 V continuously.
- Connect grounding the cable within 1 m from the area to be welded.
- Avoid seals or bearings from being between the area to be welded and the position of grounding point.

Fire prevention:

Use nonflammable cleaner or light oil for cleaning parts. Keep flame or cigarette light away from light oil.

Clamp faces:

When O-rings or gaskets are removed, clean the clamp faces and replace the O-rings and gaskets with new ones. Be sure to fit O-rings and gaskets when assembling.

Objects in your pockets:

Keep your pockets free of loose objects which can fall out and drop into the machinery; especially when you work on the machinery while bending over it.

Checking undercarriage:

When working in rocky areas, check for damage to the undercarriage and for looseness, flaws, wear and damage in bolts and nuts. Loosen the track tension a little when working in such areas.

Cleaning machine:

- Do not direct a high-pressure jet directly at the radiator.
- Do not splash water over the electrical equipment.

Pre- and post-work checks:

Before starting work in mud, rain, snow or at seashore, check plugs and valves for tightness. Wash the machine immediately after the work to protect components from rusting.

Lubricate components more frequently than usual. Be sure to lubricate work equipment pins daily if they are submerged in water.

Dusty worksites:

When working at dusty worksites, do as follows:

- Check the air cleaner for clogging more frequently. Clean the air cleaner at shorter intervals than specified.
- Clean the radiator core frequently to avoid clogging.
- Clean and replace the fuel filter frequently.
- Clean electrical components, especially the starting motor and alternator, to avoid accumulation of dust.

Avoid mixing oils:

Never mix oils of different brands. If you have only oil which is a different brand from the one that is used in the machine, do not add it but replace all the oil.

Precautions when opening and closing engine side cover

- If you open the engine side cover when on the track, always do so in a standing position.
- When the engine side cover is open, do not open or close the cab.
Before opening or closing the cab, always close the engine side cover first.

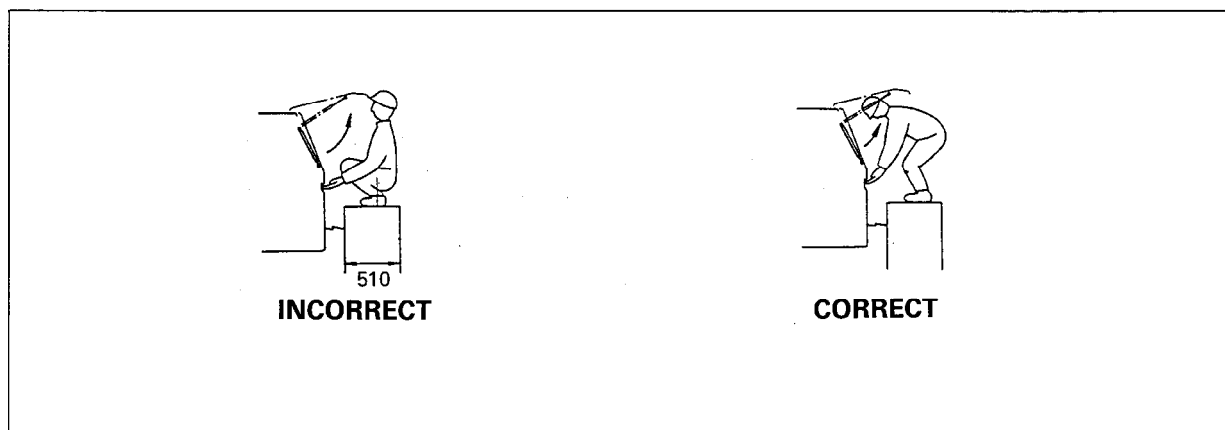

18. OUTLINES OF SERVICE

- Use Komatsu genuine parts for replacement.
- When changing or adding oil, do not use a different type of oil.
- Unless otherwise specified, the oil and coolant used at the time of shipment from the factory are as shown in the table below.

Item	Kind of fluid
Engine oil pan	SAE 15W-40 API classification CD
Power train case Final drive case	SAE 30 API classification CD
Hydraulic tank	SAE 10W API classification CD
Fuel tank	ASTM D975 No. 2 (However, ASTM D975 No. 1 is used for the winter season (October to March))
Radiator	Komatsu Super Coolant (AF-ACL) 41% added to water

18.1 OUTLINE OF OIL, FUEL, COOLANT

18.1.1 OIL

- Oil is used in the engine and work equipment under extremely severe conditions (high temperature, high pressure), and it deteriorates with use.
Always use oil that matches the grade and temperature for use given in the Operation and Maintenance Manual. Even if the oil is not dirty, always replace the oil after the specified interval.
- Oil corresponds to blood in the human body, so always be careful when handling it to prevent any impurities (water, metal particles, dirt, etc.) from getting in.
The majority of problems with machine are caused by the entry of such impurities.
Take particular care not to let any impurities get in when storing or adding oil.
- Never mix oils of different grades or brands.
- Always add the specified amount of oil.
Having too much oil or too little oil are both causes of problems.
- If the oil in the work equipment is not clear, there is probably water or air getting into the circuit. In such cases, please contact your Komatsu distributor.
- When changing the oil, always replace the related filters at the same time.
- We recommend you to have an analysis made of the oil periodically to check the condition of the machine. For those who wish to use this service, please contact your Komatsu distributor.

18.1.2 FUEL

- The fuel pump is a precision instrument, and if fuel containing water or dirt is used, it cannot work properly.
- Be extremely careful not to let impurities get in when storing or adding fuel.
- Always use the fuel specified in the Operation and Maintenance Manual.
Fuel may congeal depending on the temperature when it is used (particularly in low temperature below -15°C), so it is necessary to change to a fuel that matches the temperature.
- To prevent the moisture in the air from condensing and forming water inside the fuel tank, always fill the fuel tank after completing the day's work.
- Before starting the engine, or when 10 minutes have passed after adding fuel, drain the sediment and water from the fuel tank.
- If the engine runs out of fuel, or if the filters have been replaced, it is necessary to bleed the air from the circuit.

18.1.3 COOLANT

- River water contains large amounts of calcium and other impurities, so if it is used, scale will stick to the engine and radiator, and this will cause defective heat exchange and overheating.
Do not use water that is not suitable for drinking.
- When using anti-freeze, always observe the precautions given in the Operation and Maintenance Manual.
- Komatsu machines are supplied with Komatsu original anti-freeze in the coolant when the machine is shipped.
This anti-freeze is effective in preventing corrosion of the cooling system.
The anti-freeze can be used continuously for two years or 4000 hours. Therefore, it can be used as it is even in hot areas.
- Anti-freeze is inflammable, so be extremely careful not to expose it to flame or fire.
- The proportion of anti-freeze to water differs according to the ambient temperature.
For details of the mixing proportions, see "24.1 WHEN REQUIRED".
- If the engine overheats, wait for the engine to cool before adding coolant.
- If the coolant level is low, it will cause overheating and will also cause problems with corrosion from the air in the coolant.

18.1.4 GREASE

- Grease is used to prevent twisting and noise at the joints.
- The nipples not included in the maintenance section are nipples for overhaul, so they do not need grease.
If any part becomes stiff after being used for a long time, add grease.
- Always wipe off all of the old grease that is pushed out when greasing. Be particularly careful to wipe off the old grease in places where sand or dirt sticking in the grease would cause wear of the rotating parts.

18.1.5 STORING OIL AND FUEL

- Keep indoors to prevent any water, dirt, or other impurities from getting in.
- When keeping drum cans for a long period, put the drum on its side so that the filler port of the drum can is at the side. (To prevent moisture from being sucked in)
If drum cans have to be stored outside, cover them with a waterproof sheet or take other measures to protect them.
- To prevent any change in quality during long-term storage, be sure to use in the order of first in — first out (use the oldest oil or fuel first).

18.1.6 FILTERS

- Filters are extremely important safety parts. They prevent impurities in the fuel and air circuits from entering important equipment and causing problems.
Replace all filters periodically. For details, see the Operation and Maintenance Manual.
However, when working in severe conditions, it is necessary to consider replacing the filters at shorter intervals according to the oil and fuel (sulfur content) being used.
- Never try to clean the filters (cartridge type) and use them again. Always replace with new filters.
- When replacing oil filters, check if any metal particles are stuck to the old filter. If any metal particles are found, please contact your Komatsu distributor.
- Do not open packs of spare filters until just before they are to be used.
- Always use Komatsu genuine filters.

18.2 RELATING TO ELECTRIC SYSTEM

- If the wiring gets wet or the insulation is damaged, the electric system leaks and this could result in hazardous malfunction of the machine.
- Services relating to the electric system are (1) check of fan belt tension, (2) check of damage or wear in the fan belt and (3) check of battery fluid level.
- Never remove or disassemble any electric components installed in the machine.
- Never install any electric components other than these specified by Komatsu.
- Be careful to keep the electric system free of water when washing the machine or when it rains.
- When working on the seashore, carefully clean the electric system to prevent corrosion.
- Never connect any optional power source to the fuse, starting switch, battery relay, etc.

19. WEAR PARTS LIST

Wear parts such as the filter element, cutting edge, etc. are to be replaced at the time of periodic maintenance or before their abrasion limits.

The wear parts should be changed correctly in order to use the machine economically.

For part change, Komatsu genuine parts of excellent quality should be used.

The parts in parentheses are to be replaced at the same time.

Item	Part No.	Part Name	Weight	Q'ty	Replacement frequency
Power train filter	07063-01054 (07000-72100)	Element (O-ring)	— —	1 (1)	Every 250 hours service
Engine oil filter (D65P, EX, PX)	600-211-1230	Cartridge	—	1	Every 250 hours service
Engine oil filter (D65E)	6136-51-5120	Cartridge	—	1	Every 500 hours service
Fuel filter	600-311-8292	Cartridge	—	1	Every 500 hours service
Corrosion resistor (D65P, EX, PX)	600-411-1150	Cartridge	—	1	Every 1000 hours service
Hydraulic oil filter	07063-01100 (07000-02135)	Element (O-ring)	— —	1 (1)	Every 2000 hours service
Air cleaner	6125-81-7032	Element ass'y	—	1	—
	600-181-4300	Outer element ass'y	—	1	
Electrical intake air heater	6150-11-4820	Gasket	—	2	—
Blade (D65E, EX · Tiltadozer)	14X-71-11310	Cutting edge	38.4 kg	2	—
	144-70-11251	End bit (left)	—	1	
	144-70-11261	End bit (right)	—	1	
	(02090-11270)	(Bolt)	—	(28)	
	(02290-11219)	(Nut)	—	(28)	
Blade (D65P, PX · Tiltadozer · Tilt pitch dozer)	14Y-71-11210	Cutting edge	45.5 kg	2	—
	13F-Z27-1582	End bit (left)	—	1	
	13F-Z27-1572	End bit (right)	—	1	
	(02090-11270)	(Bolt)	—	(32)	
	(02290-11219)	(Nut)	—	(32)	
Blade (D65E, EX · Angledozer)	144-70-11131	Cutting edge	45.5 kg	2	—
	144-70-11251	End bit (left)	—	1	
	144-70-11261	End bit (right)	—	1	
	(02090-11270)	(Bolt)	—	(32)	
	(02290-11219)	(Nut)	—	(32)	
Semi U-blade (D65E, EX · Tiltadozer)	14X-952-1130	Cutting edge	34.8 kg	2	—
	150-70-21356	End bit (left)	26.2 kg	1	
	150-70-21346	End bit (right)	26.2 kg	1	
	(02090-11285)	(Bolt)	—	(16)	
	(02090-11270)	(Bolt)	—	(12)	
	(02290-11219)	(Nut)	—	(28)	

NOTICE

When handling parts that weigh more than 20 kg, remember that they are heavy objects, and take the necessary care.

20. USE OF FUEL, COOLANT AND LUBRICANTS ACCORDING TO AMBIENT TEMPERATURE

PROPER SELECTION OF FUEL, COOLANT AND LUBRICANTS

RESERVOIR	KIND OF FLUID	AMBIENT TEMPERATURE								CAPACITY	
		-22 -30	-4 -20	14 -10	32 0	50 10	68 20	86 30	104°F 40°C	Specified	Refill
Engine oil pan	Engine oil	SAE 30								44ℓ 11.62 US gal 9.68 UK gal	38ℓ 10.03 US gal 8.36 UK gal
		SAE 10W									
		SAE 10W-30									
		SAE 15W-40									
Power train case	Engine oil									75ℓ 19.8 US gal 16.5 UK gal	50ℓ 13.2 US gal 11.0 UK gal
Final drive case (each)		SAE 30								24ℓ (each) 6.34 US gal 5.28 UK gal (D65E, EX-12)	24ℓ (each) 6.34 US gal 5.28 UK gal (D65E, EX-12)
		SAE 10W								27ℓ (each) 7.13 US gal 5.94 UK gal (D65P, PX-12)	27ℓ (each) 7.13 US gal 5.94 UK gal (D65P, PX-12)
Hydraulic system	Engine oil	SAE 10W								95ℓ 25.08 US gal 20.9 UK gal	55ℓ 14.52 US gal 12.1 UK gal
SAE 10W-30											
SAE 15W-40											
Idler (each)	Diesel fuel	SAE 30								0.15ℓ (each) 0.04 US gal 0.03 UK gal	0.15ℓ (each) 0.04 US gal 0.03 UK gal
Fuel tank		ASTM D975 No. 2								340ℓ 89.76 US gal 74.8 UK gal	—
		*									
Cooling system (incl. sub-tank)	Water	Add antifreeze								58.2ℓ 15.36 US gal 12.8 UK gal	—

※ ASTM D975 No. 1

REMARK

- When fuel sulphur content is less than 0.5%, change oil in the oil pan every periodic maintenance hours described in this manual.
Change oil according to the following table if fuel sulphur content is above 0.5%.

Fuel sulphur content	Change interval of oil in engine oil pan
0.5 to 1.0%	1/2 of regular interval
Above 1.0%	1/4 of regular interval

- When starting the engine in an atmospheric temperature of lower than 0°C, be sure to use engine oil of SAE10W, SAE10W-30 and SAE15W-40, even though an atmospheric temperature goes up to 10°C more or less in the day time.
- Use API classification CD as engine oil and if API classification CC, reduce the engine oil change interval to half.
- There is no problem if single grade oil is mixed with multigrade oil (SAE10W-30, 15W-40), but be sure to add single grade oil that matches the temperature in the table.
- We recommend Komatsu genuine oil which has been specifically formulated and approved for use in engine and hydraulic work equipment applications.

Specified capacity: Total amount of oil including oil for components and oil in piping.

Refill capacity: Amount of oil needed to refill system during normal inspection and maintenance.

ASTM: American Society of Testing and Material

SAE: Society of Automotive Engineers

API: American Petroleum Institute

20. USE OF FUEL, COOLANT AND LUBRICANTS ACCORDING TO AMBIENT TEMPERATURE

No.	Supplier	Engine Oil [CD or CE] SAE10W, 30, 40 10W30, 15W40 (The 15W40 oil marked * is CE.)	Gear Oil [GL-4 or GL-5] SAE80, 90, 140	Grease [Lithium-Base] NLGI No. 2	Anti-freeze Coolant [Ethylene Glycol Base] Permanent Type
1	KOMATSU	EO10-CD EO30-CD EO10-30CD EO15-40CD	GO90 GO140	G2-LI G2-LI-S	AF-ACL AF-PTL AF-PT (Winter, one season type)
2	AGIP	Diesel sigma S Super dieselmulti- grade *Sigma turbo	Rotra MP	GR MU/EP	—
3	AMOCO	*Amoco 300	Multi-purpose gear oil	RYKON premium grease	—
4	ARCO	*Arcofleet S3 plus	Arco HD gear oil	Litholine HEP 2 Arco EP moly D	—
5	BP	Vanellus C3	Gear oil EP Hypogear EP	Energrease LS-EP2	Antifreeze
6	CALTEX	*RPM delo 400 RPM delo 450	Universal thuban Universal thuban EP	Marfak all purpose 2 Ultra-duty grease 2	AF engine coolant
7	CASTROL	*Turbomax *RX super CRD	EP EPX Hypoy Hypoy B Hypoy C	MS3 Spheerol EPL2	Anti-freeze
8	CHEVRON	*Delo 400	Universal gear	Ultra-duty grease 2	—
9	CONOCO	*Fleet motor oil	Universal gear lubricant	Super-sta grease	—
10	ELF	Multiperformance 3C Performance 3C	—	Tranself EP Tranself EP type 2	Glacelf
11	EXXON (ESSO)	Essolube D3 *Essolube XD-3 *Essolube XD-3 Extra *Esso heavy duty Exxon heavy duty	Gear oil GP Gear oil GX	Beacon EP2	All season coolant
12	GULF	Super duty motor oil *Super duty plus	Multi-purpose gear lubricant	Gulfcrown EP2 Gulfcrown EP special	Antifreeze and coolant
13	MOBIL	Delvac 1300 *Delvac super 10W-30, 15W-40	Mobilube GX Mobilube HD	Mobilux EP2 Mobilgrease 77 Mobilgrease special	—

20. USE OF FUEL, COOLANT AND LUBRICANTS ACCORDING TO AMBIENT TEMPERATURE

No.	Supplier	Engine Oil [CD or CE] SAE10W, 30, 40 10W30, 15W40 (The 15W40 oil marked * is CE.)	Gear Oil [GL-4 or GL-5] SAE80, 90, 140	Grease [Lithium-Base] NLGI No. 2	Anti-freeze Coolant [Ethylene Glycol Base] Permanent Type
14	PENNZOIL	*Supreme duty fleet motor oil	Multi-purpose 4092 Multi-purpose 4140	Multi-purpose white grease 705 707L White – bearing grease	Anti-freeze and summer coolant
15	PETROFINA	FINA kappa TD	FINA potonic N FINA potonic NE	FINA marson EPL2	FINA tamidor
16	SHELL	Rimula X	Spirax EP Spirax heavy duty	Alvania EP grease	—
17	SUN	—	Sunoco GL5 gear oil	Sunoco ultra prestige 2EP Sun prestige 742	Sunoco antifreeze and summer coolant
18	TEXACO	*Ursa super plus Ursa premium	Multigear	Multifak EP2 Starplex 2	Code 2055 startex antifreeze coolant
19	TOTAL	Rubia S *Rubia X	Total EP Total transmission TM	Multis EP2	Antigel/antifreeze
20	UNION	*Guardol	MP gear lube LS	Unoba EP	—
21	VEEDOL	*Turbostar *Diesel star MDC	Multigear Multigear B Multigear C	—	Antifreeze

21. STANDARD TIGHTENING TORQUES FOR BOLTS AND NUTS

21.1 INTRODUCTION OF NECESSARY TOOLS

The following tools are needed when carrying out maintenance.

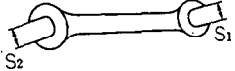
No.	Name of tool	Part No.	Remarks
1	Wrench set	09000-30006	Applicable width across flats ($S_1 - S_2$) 8 mm – 10 mm, 12 mm – 14 mm 13 mm – 17 mm, 19 mm – 22 mm 24 mm – 27 mm, 30 mm – 32 mm
			
2	Screwdriver	09033-00190	Interchangeable flat-head and cross-head type
3	Socket wrench set	09020-10285	Applicable width across flats 10 mm, 13 mm, 14 mm, 17 mm, 19 mm, 22 mm, 24 mm Extension, Handle
4	Socket	09021-03653	Applicable width across flats 36 mm for mounting trunnion
5	Handle	09024-00300	
6	Filter wrench	09019-08035	For filter cartridges
7	Socket	09084-01422	For corrosion resistor (D65P, D65EX, D65PX)
8	Grease pump	07952-70002	For greasing work
9	Grease cartridge	07950-90403	(Lithium base grease, 400 g)

If any of the above tools are broken, please order them from your Komatsu distributor.

When not using the tools, always put them in the tool box on the inside of the battery inspection cover on the left side of the machine.

21.2 TORQUE LIST

Unless otherwise specified, tighten the metric bolts and nuts to the torque shown in the table.

The tightening torque is determined by the width across the flats $\text{\textcircled{H}}$ of the nut and bolt.

If it is necessary to replace any nut or bolt, always use a Komatsu genuine part of the same size as the part that was replaced.

Nm (newton meter): $1\text{Nm} \doteq 0.1 \text{kgm}$
 $\doteq 0.74 \text{lbft}$

Thread diameter of bolt (mm) (a)	Width across flat (mm) (b)	AD054300		
		Nm	kgm	lbft
6	10	13.2 ± 1.4	1.35 ± 0.15	9.73 ± 1.03
8	13	31.4 ± 2.9	3.2 ± 0.3	23.2 ± 2.1
10	17	65.7 ± 6.8	6.7 ± 0.7	48.5 ± 5.0
12	19	112 ± 9.8	11.5 ± 1.0	82.6 ± 7.2
14	22	177 ± 19	18.0 ± 2.0	131 ± 14
16	24	279 ± 29	28.5 ± 3	206 ± 21
18	27	383 ± 39	39 ± 3	282 ± 29
20	30	549 ± 58	56 ± 6	405 ± 43
22	32	745 ± 78	76 ± 8	549 ± 58
24	36	927 ± 98	94.5 ± 10	684 ± 72
27	41	1320 ± 140	135 ± 15	973 ± 100
30	46	1720 ± 190	175 ± 20	1270 ± 140
33	50	2210 ± 240	225 ± 25	1630 ± 180
36	55	2750 ± 290	280 ± 30	2030 ± 210
39	60	3280 ± 340	335 ± 35	2420 ± 250

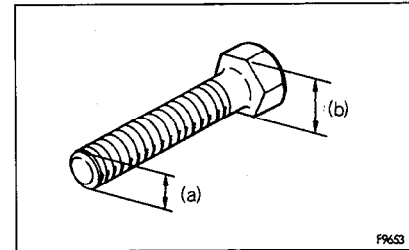

NOTICE

When tightening panels or other parts having tightening fixtures made of plastic, be careful not to use excessive tightening torque: doing so will damage the plastic parts.

22. PERIODIC REPLACEMENT OF SAFETY CRITICAL PARTS

To ensure safety at all times when operating or driving the machine, the user of the machine must always carry out periodic maintenance. In addition, to further improve safety, the user should also carry out periodic replacement of the parts given in the table. These parts are particularly closely connected to safety and fire prevention.

With these parts, the material changes as time passed, or they easily wear or deteriorate. However, it is difficult to judge the condition of the parts simply by periodic maintenance, so they should always be replaced after a fixed time has passed, regardless of their condition. This is necessary to ensure that they always maintain their function completely.

However, if these parts show any abnormality before the replacement interval has passed, they should be repaired or replaced immediately.

If the hose clamps show any deterioration, such as deformation or cracking, replace the clamps at the same as the hoses.

When replacing the hoses, always replace the O-rings, gaskets, and other such parts at the same time.

Ask your Komatsu distributor to replace the critical parts.

- D65E, P-12

No.	Safety critical parts for periodic replacement	Q'ty	Replacement interval
①	Fuel hose (fuel tank – injection pump)	1	Every 2 years or 4000 hours, whichever comes sooner
②	Fuel hose (injection pump – fuel filter)	2	
③	Fuel return hose (injection pump – fuel tank)	1	
④	Fuel return hose (injection nozzle – fuel tank)	1	
⑤	Hose (power train strainer – power train pump)	1	
⑥	Hose (power train pump – power train filter)	1	
⑦	Hose (power train filter – transmission case)	1	
⑧	Hose (transmission case – steering relief valve)	1	
⑨	Hose (power train lubrication pump – steering case)	1	
⑩	Hose (scavenging pump – steering case)	1	
⑪	Hose (torque converter case – transmission oil cooler)	1	
⑫	Hose (transmission oil cooler – transmission case)	1	
⑬	Brake pressure detection hose	2	
⑭	Steering clutch pressure detection hose	2	
⑮	Transmission modulation pressure detection hose	1	
⑯	Torque converter inlet port pressure detection hose	1	
⑰	Torque converter outlet port pressure detection hose	1	
⑱	Seat belt		Replace every 3 years

22. PERIODIC REPLACEMENT OF SAFETY CRITICAL PARTS

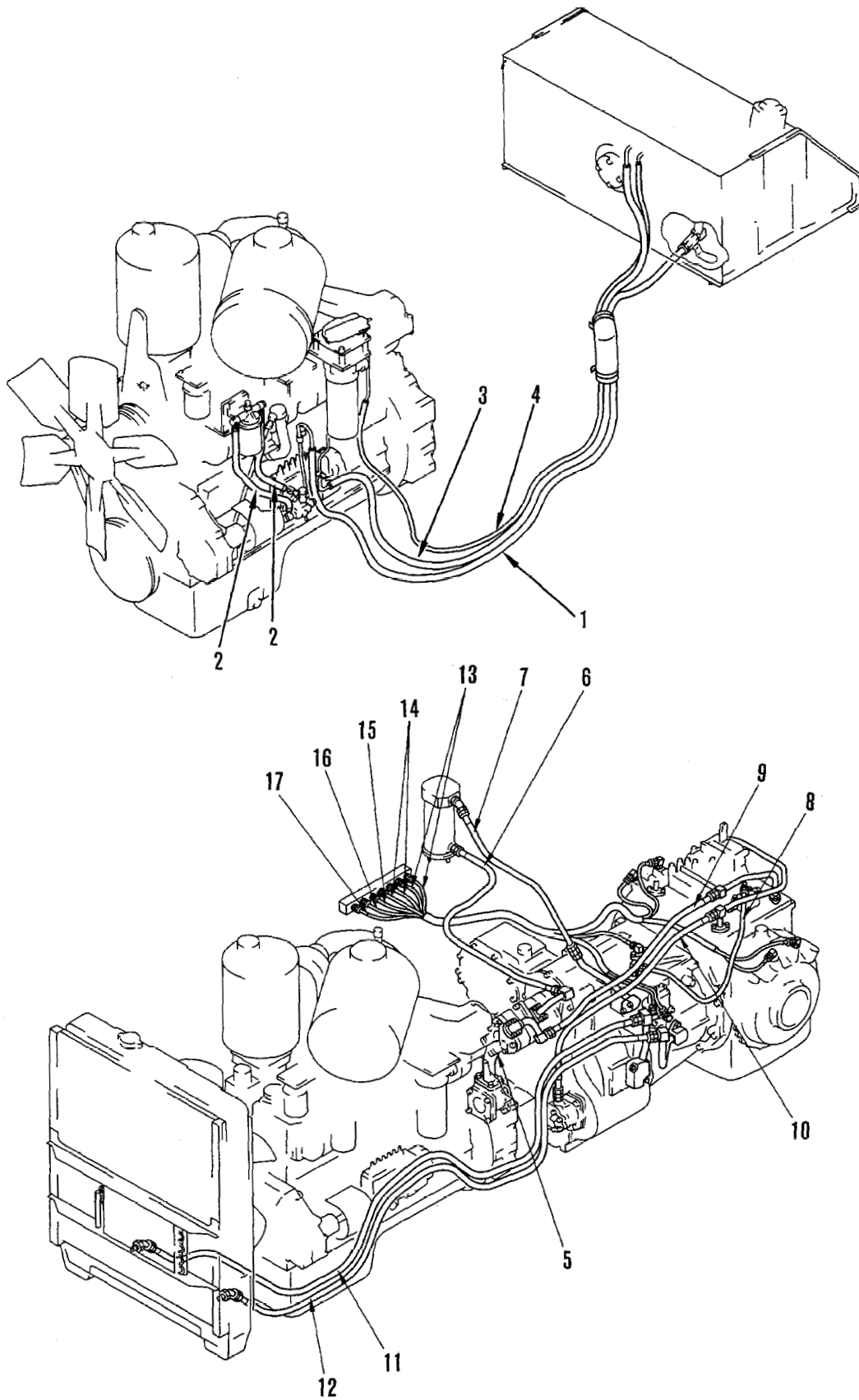

22. PERIODIC REPLACEMENT OF SAFETY CRITICAL PARTS

- D65EX, PX-12

No.	Safety critical parts for periodic replacement	Q'ty	Replacement interval
①	Fuel hose (fuel tank – injection pump)	1	Every 2 years or 4000 hours, whichever comes sooner
②	Fuel hose (injection pump – fuel filter)	2	
③	Fuel return hose (injection pump – fuel tank)	1	
④	Fuel return hose (injection nozzle – fuel tank)	1	
⑤	Hose (PPC charge valve – PPC valve)	1	
⑥	Hose (hydraulic tank – PPC valve)	1	
⑦	Hose (PPC valve – main valve)	2	
⑧	Hose (PPC pump – PPC charge valve)	1	
⑨	Hose (PPC charge valve – hydraulic tank)	1	
⑩	Hose (power train strainer – power train pump)	1	
⑪	Hose (power train pump – power train filter)	1	
⑫	Hose (power train filter – transmission case)	1	
⑬	Hose (transmission case – steering case)	1	
⑭	Hose (power train lubrication pump – steering case)	1	
⑮	Hose (scavenging pump – steering case)	1	
⑯	Hose (torque converter case – transmission oil cooler)	1	
⑰	Hose (transmission oil cooler – transmission case)	1	
⑱	Brake pressure detection hose	1	
⑲	Torque converter inlet port pressure detection hose	1	
⑳	Torque converter outlet port pressure detection hose	1	
㉑	Transmission modulation pressure detection hose	1	
㉒	Hose (hydraulic tank – HSS pump)	2	
㉓	Hose (HSS pump – PPC pump)	1	
㉔	Hose (HSS pump – main valve)	1	
㉕	Hose (main valve – HSS motor)	2	
㉖	Hose (HSS motor – hydraulic tank)	2	
㉗	Seat belt		Replace every 3 years

22. PERIODIC REPLACEMENT OF SAFETY CRITICAL PARTS

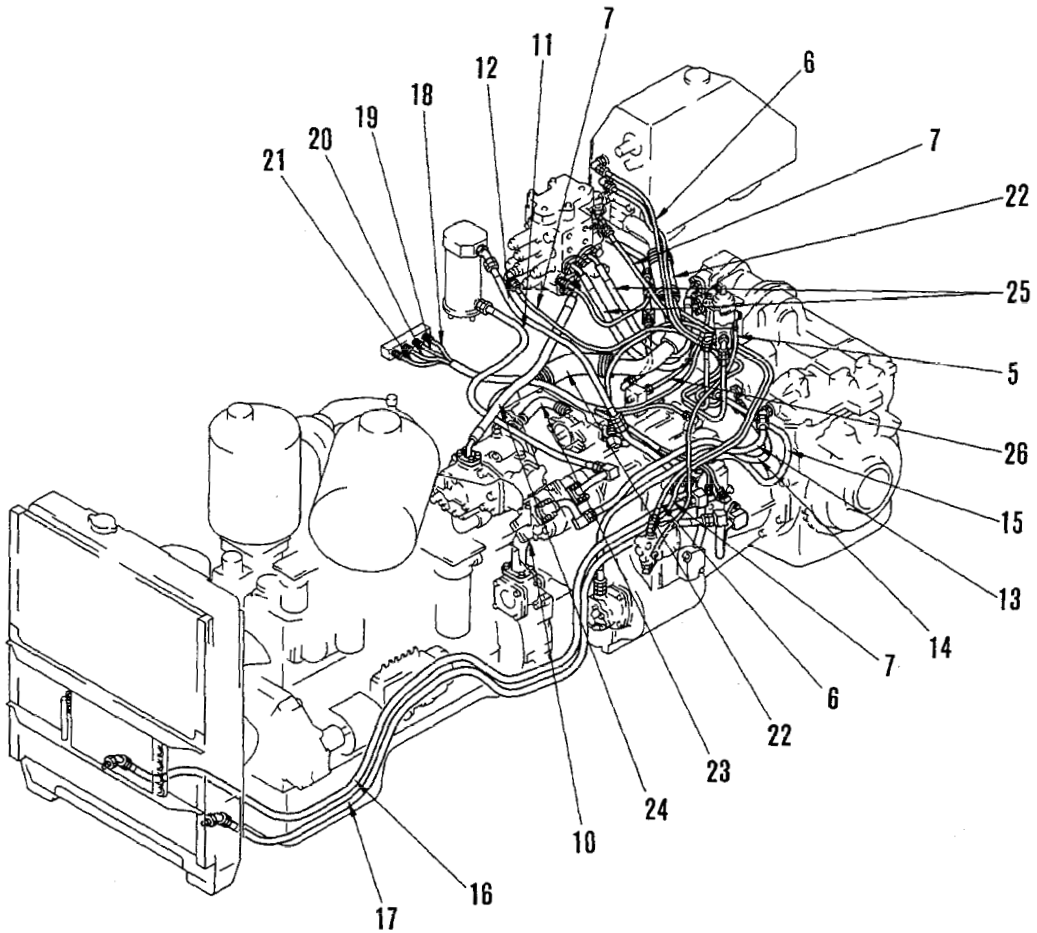
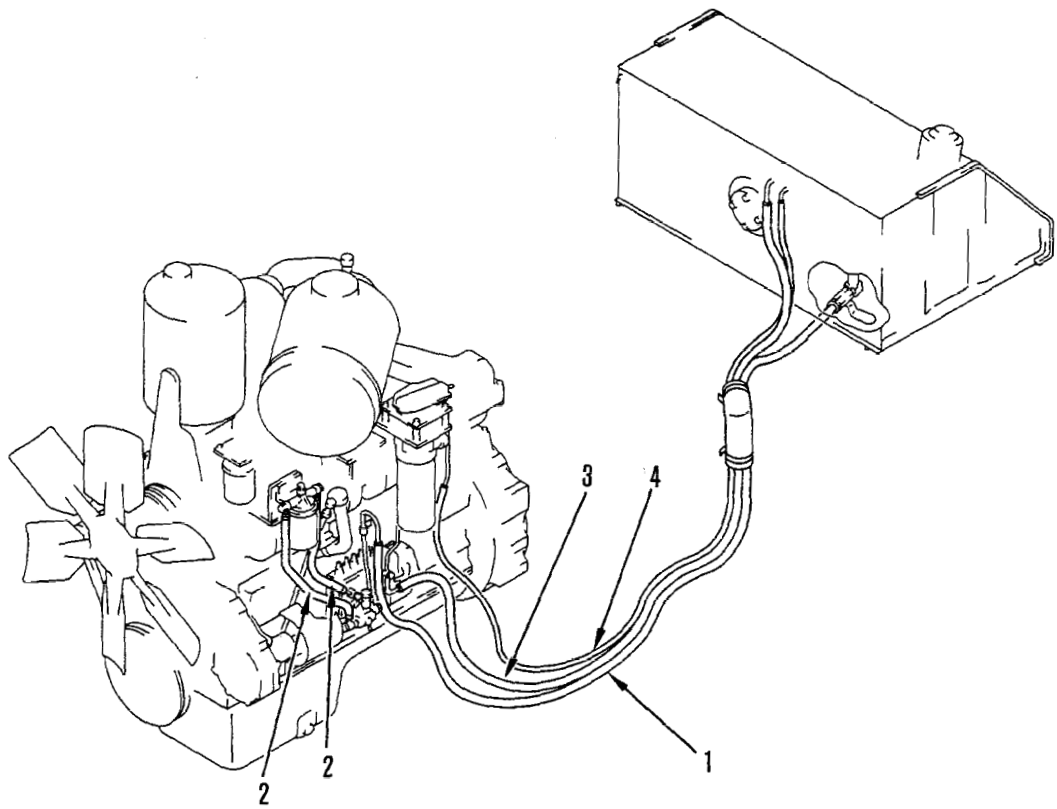

23. MAINTENANCE SCHEDULE CHART

23.1 MAINTENANCE SCHEDULE CHART

SERVICE ITEM	PAGE
WHEN REQUIRED	
Clean inside of cooling system	3-23
Check, clean and replace air cleaner element	3-27
Check track tension	3-29
Check and tighten track shoe bolts	3-31
Check electrical intake air heater	3-31
Reverse and replace the end bits and cutting edges	3-32
Clean, check radiator fins	3-34
Adjust idler clearance	3-35
Adjusting tension of center brace (Power tilt and Power tilt, power pitch dozer only)	3-36
Clean air conditioner air filter (FRESH/RECIRC filter) (Machines equipped with cab)	3-37
Check, Adjust air conditioner (Machines equipped with cab)	3-38
Grease door hinge (Machines equipped with cab)	3-38
Check door lock striker (Machines equipped with cab)	3-39
Replace door damper (Machines equipped with cab)	3-39
Check window washer fluid level, add fluid (Machines equipped with cab)	3-39
Bleed air from head end of right pitch cylinder (Power tilt, power pitch dozer only)	3-39
Replace wiper blade (Machines equipped with cab)	3-40
Check idler oil level, add oil	3-41
CHECK BEFORE STARTING	
Check coolant level, add water	3-42
Checking with machine monitor (Monitor panel specification)	3-42
Check fuel level, add fuel (Monitor panel specification)	3-43
Check fuel level, add fuel (Gauge panel specification)	3-43
Check oil level in engine oil pan, add oil	3-44
Check oil level in power train case, add oil	3-45
Check brake pedal travel	3-45
Check dust indicator	3-45
Check that lamps light up	3-46
Check horn sound	3-46
Check backup alarm sound	3-46

SERVICE ITEM	PAGE
Check seat belt for wear or damage	3-46
Check for water and sediment in water separator, drain water	3-46
EVERY 50 HOURS SERVICE	
Drain water, sediment from fuel tank	3-47
EVERY 250 HOURS SERVICE	
Lubricating	3-48
(Power tilt dozer)	
• Lift cylinder support yoke (4 places)	3-48
• Lift cylinder support shaft (2 places)	3-48
• Lift cylinder ball joint (2 places)	3-48
• Tilt cylinder ball joint (1 place)	3-48
• Tilt brace ball joint (1 place)	3-48
• Brace ball joint (2 places)	3-48
• Tilt brace thread (1 place)	3-48
(Power tilt power pitch dozer)	
• Lift cylinder support yoke (4 places)	3-49
• Lift cylinder support shaft (2 places)	3-49
• Lift cylinder ball joint (2 places)	3-49
• Tilt cylinder ball joint (1 place)	3-49
• Pitch cylinder ball joint (1 place)	3-49
• Brace ball joint (2 places)	3-49
(Angledozer)	
• Lift cylinder support yoke (4 places)	3-50
• Lift cylinder support shaft (2 places)	3-50
• Lift cylinder ball joint (2 places)	3-50
• Tilt brace ball joint (2 places)	3-50
• Tilt brace thread (2 places)	3-50
Grease equalizer bar side pin	3-51
Check oil level in final drive case, add oil	3-51
Check oil level in hydraulic tank, add oil	3-52
Change oil in engine oil pan, replace engine oil filter cartridge (D65P, 65EX, PX only)	3-53

23. MAINTENANCE SCHEDULE CHART

SERVICE ITEM	PAGE
(EVERY 250 HOURS SERVICE)	
Check level of battery electrolyte	3-55
Check fan belt tension, adjust	3-56
Drain water and sediment from fuel filter	3-57
Check, clean additional fuel strainer	3-57
Replace power train oil filter element	3-58
Check brake capacity	3-59
EVERY 500 HOURS SERVICE	
Replace fuel filter cartridge	3-60
Change oil in engine oil pan, replace engine oil filter cartridge (D65E only)	3-62
EVERY 1000 HOURS SERVICE	
Change oil in power train case, clean strainers (power train strainer, scavenging pump strainer)	3-64
Change oil in final drive case	3-66
Clean power train (transmission) case breather (1 place)	3-67
Grease universal joint (2 places)	3-67
Replace corrosion resistor cartridge (D65P, D65EX, PX only)	3-68
Check all tightening parts of turbocharger (D65P, D65EX, PX only)	3-68
Check play of turbocharger rotor (D65P, D65EX, PX only)	3-68
Check for loose Rops mount bolts	3-68
EVERY 2000 HOURS SERVICE	
Change oil in hydraulic tank, replace hydraulic oil filter element	3-69
Clean, check turbocharger (D65P, D65EX, PX only)	3-71
Clean engine breather element	3-71
Check vibration damper	3-71
Check alternator, starting motor	3-71
Check engine valve clearance, adjust	3-71
EVERY 4000 HOURS SERVICE	
Check water pump	3-72

24. SERVICE PROCEDURE

24.1 WHEN REQUIRED

24.1.1 CLEAN INSIDE OF COOLING SYSTEM

 **WARNING**

- **Soon after the engine has been stopped, the coolant is hot and can cause personal injury. Allow the engine to cool before draining water.**
 - **Never be under the machine with the engine running. To avoid serious injury, always stop the engine before being under the machine to open the drain valve.**
 - **Never remove the radiator cap when the engine is at operating temperature. At operating temperature, the coolant is under pressure. Steam blowing up from the radiator could cause personal injury. Allow the engine to cool until the radiator filler cap is cool enough to touch with your hand. Remove the filler cap slowly to relieve pressure.**
 - **When removing drain plug, avoid pouring coolant on yourself.**
 - **Antifreeze is flammable, so keep it away from any flame.**
- Clean the inside of the cooling system, change the coolant and replace the corrosion resistor according to the table below.

Kind of coolant	Cleaning inside of cooling system and changing coolant	Replacing corrosion resistor
Permanent type antifreeze (All season type)	Every year (autumn) or every 2000 hours whichever comes first	
Non permanent type antifreeze containing ethylene glycol (Winter, one season type)	Every 6 months (spring, autumn) (Drain antifreeze in spring, add antifreeze in autumn)	Every 1000 hours and when cleaning the inside of the cooling system and when changing coolant
When not using antifreeze	Every 6 months or every 1000 hours whichever comes first	

- Use a permanent type of antifreeze.
If, for some reason, it is impossible to use permanent type antifreeze, use an antifreeze containing ethylene glycol.
- Stop the machine on level ground when cleaning or changing the coolant.
- When deciding the ratio of antifreeze to water, check the lowest temperature in the past, and decide from the mixing rate table given below.
It is actually better to estimate a temperature about 10°C lower when deciding the mixing rate.

Mixing rate of water and antifreeze

Min. atmospheric temperature (°C)	-5	-10	-15	-20	-25	-30
Amount of antifreeze (ℓ)	13.4	17.5	21.0	23.9	26.8	29.1
Amount of water (ℓ)	44.8	40.7	37.2	34.3	31.4	29.1

- We recommend use of an antifreeze density gauge to control the mixing proportions.
- Use city water for the cooling water.
If river water, well water or other such water supply must be used, contact your Komatsu distributor.

1. Turn radiator cap ① slowly to remove it.
2. Set a container to catch the coolant under drain valve ② and drain plug ③. Open drain valve ② at the bottom of the radiator and drain plug ③ on the side face of the cylinder block to drain the water.
3. After draining the water, close drain valve ② and drain plug ③, and fill with city water.
4. Open drain valve ② and drain plug ③, run the engine at low idling, and flush water through the system for 10 minutes. When doing this, adjust the speed of filling and draining the water so that the radiator is always full. While flushing water through the system, watch carefully that the water inlet hose does not come out of the radiator water filler.
5. After flushing, stop the engine, open drain valve ② and drain plug ③, then close it again after all the water has drained out.
6. After draining the water, clean with a flushing agent. When washing, follow the instructions given with the detergent.
7. After flushing, open drain valve ② and drain plug ③, completely drain all the water, then close the drain valve and drain plug, and fill with city water up to near the filler port.
8. When the tank is filled to near the water filler port, open drain valve ② and drain plug ③, start the engine, run at low idling, and continue the flushing operation until clean water comes out. Adjust the amount of water flowing in and out to ensure that the radiator is always full during the flushing operation.
9. When clean water comes out, stop the engine, and close drain valve ② and drain plug ③.
10. Add city water until the water overflows from the water filler port.

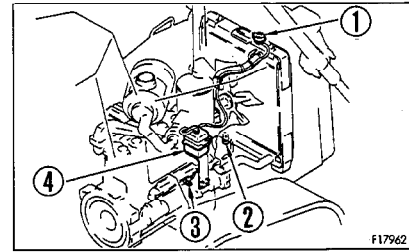

24. SERVICE PROCEDURE

11. To remove the air in the cooling water, run for five minutes at low idling, then for another five minutes at high idling.

(When doing this, leave the radiator cap off.)

12. Drain the cooling water inside sub-tank ④, clean the inside of the sub-tank, then fill again with cooling water to a point midway between the FULL and LOW marks.

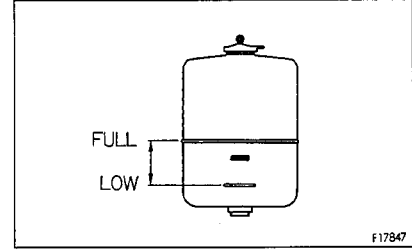

13. Stop the engine, wait for 3 minutes, add city water until the water level reaches near the water filler port, then tighten the cap.

24.1.2 CHECK, CLEAN AND REPLACE AIR CLEANER ELEMENT

WARNING

- Never clean or replace the air cleaner element with the engine running.
- When using pressure air to clean the element wear safety glasses or goggles to protect the eyes.

Checking

Whenever the red piston in dust indicator ① appears, clean the air cleaner element.

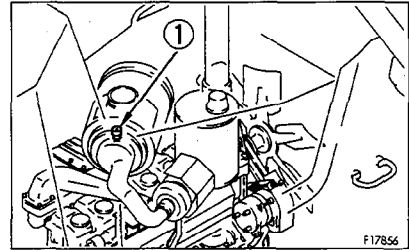

Cleaning or replacing outer element

1. Loosen bolt ②, remove cover ③ and the outer element.
2. Clean the air cleaner body interior and the dust cup.

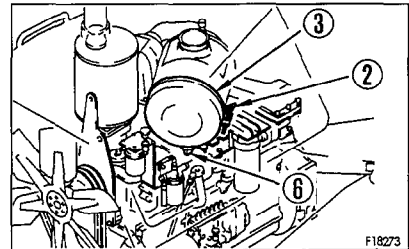

3. Direct dry compressed air (less than 7 kg/cm²) to the element from inside along its folds, then direct it from outside along its folds and again from inside.

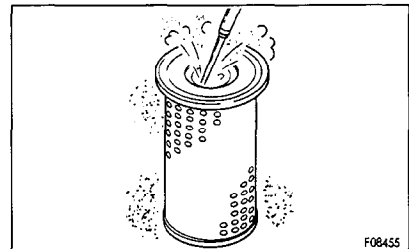

- 1) Remove one seal from the outer element. The number of times the outer element has been cleaned can be seen by the number of removed seals.
- 2) Replace the outer element which has been cleaned 6 times repeatedly or used throughout a year. Replace the inner element at the same time.
- 3) Replace the element when the air cleaner clogged warning lamp lights up soon after installing the cleaned element even though it has not been cleaned 6 times.
- 4) Check inner element mounting nuts for looseness and, if necessary, retighten.
- 5) Replace seal washer ④ or wing nut ⑤ with new parts if they are broken.
- 6) Remove evacuator valve ⑥ and clean with compressed air. After cleaning, install it.

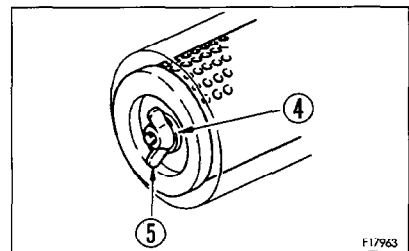

NOTICE

If small holes or thinner parts are found on the element when it is checked with an electric bulb after cleaning and drying, replace the element.

Do not use an element whose folds or gasket or seal are damaged.

When cleaning the element, do not hit it or beat it against something.

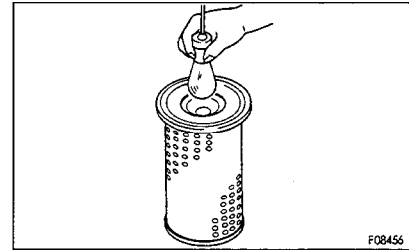

4. Set the cleaned element and cover ③.

Replacing inner element

1. First remove the cover and the outer element, and then remove the inner element.
2. To prevent dust from getting in, use a clean cloth or tape to cover the air connector (outlet side).
3. Clean the air cleaner body interior, then remove the cover installed in Step 2.
4. Fit a new inner element to the connector and tighten it with nuts. Do not clean and reinstall a inner element.
5. Install the outer element and the cover.
6. After replacing the element, return the red piston in the dust indicator to its original position.

24.1.3 CHECK TRACK TENSION

The wear of pins and bushings on the undercarriage will vary with the working conditions and soil properties. It is thus necessary to continually inspect the track tension so as to maintain the standard tension.

Carry out the check and adjustment under the same conditions as when operating (on jobsites where the track becomes clogged with mud, measure with the track clogged with mud).

Inspection

Stop the machine on level ground (stop with the transmission in FORWARD without applying the brake). Then place a straight bar on the track shoes between the carrier roller and the idler as shown in the figure, and measure the clearance between the bar and the grouser at the midpoint. If the clearance is 20 – 30 mm, the tension is standard.

If the track tension is not at the standard value, adjust it in the following manner.

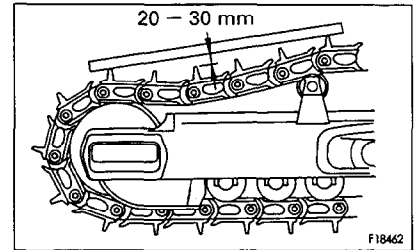

Adjustment

⚠ WARNING

Grease inside the adjusting mechanism is under high pressure. Grease coming from lubricator ① under pressure can penetrate the body causing injury or death. For this reason, do not loosen lubricator ① more than one turn. Do not loosen any part other than lubricator ①. Furthermore, do not bring your face in front of the grease fitting.

If the track tension is not relieved by this procedure, please contact your Komatsu distributor.

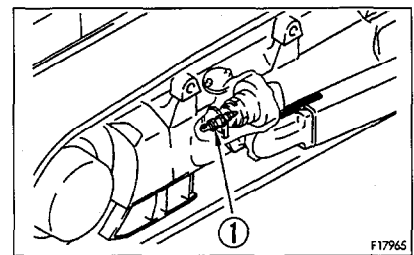

- When increasing tension
1. Pump in grease through the grease fitting with a grease pump.
 2. To check that the correct tension has been achieved, move the machine backwards and forwards.
 3. Check the track tension again, and if the tension is not correct, adjust it again.
 4. Continue to pump in grease until S becomes 0 mm. If the tension is still loose, the pin and bushing are excessively worn, so they must be either turned or replaced. Please contact your Komatsu distributor.

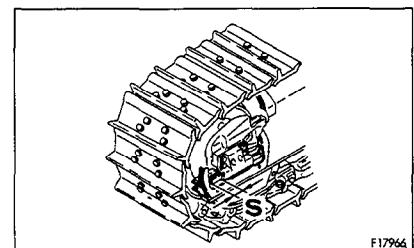

- When loosening tension

⚠ WARNING

It is extremely dangerous to release the grease by any method except the procedure given below. If the track tension is not relieved by this procedure, please contact your Komatsu distributor.

1. Loosen lubricator ① gradually to release the grease.
2. Turn lubricator ① a maximum of one turn.
3. If the grease does not come out smoothly, move the machine backwards and forwards a short distance.
4. Tighten lubricator ①.
5. To check that the correct tension has been achieved, move the machine backwards and forwards.
6. Check the track tension again, and if the tension is not correct, adjust it again.

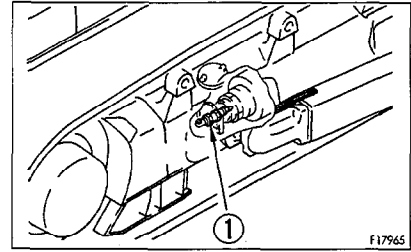

24.1.4 CHECK AND TIGHTEN TRACK SHOE BOLTS

If the machine is used with track shoe bolts ① loose, they will break, so tighten any loose bolts immediately.

- **Method for tightening (shoe bolt)**

1. First tighten to a tightening torque of 40 ± 4 kgm, then check that the nut and shoe are in close contact with the link contact surface.
2. After checking, tighten a further $120^\circ \pm 10^\circ$.

- **Method for tightening (master link connecting bolt)**

1. First tighten to a tightening torque of 35 ± 4 kgm, then check that the link contact surfaces are in close contact.
2. After checking, tighten a further $180^\circ \begin{smallmatrix} +0^\circ \\ -20^\circ \end{smallmatrix}$.

Order for tightening

Tighten the bolts in the order shown in the diagram on the right.

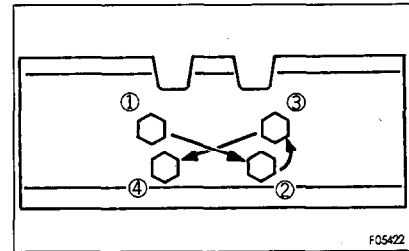
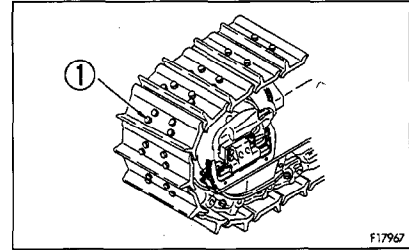

24.1.5 CHECK ELECTRICAL INTAKE AIR HEATER

Before the start of the cold season (once a year), contact your Komatsu distributor to have the electrical intake air heater repaired or checked for dirt or disconnections.

24.1.6 REVERSE AND REPLACE THE END BITS AND CUTTING EDGES

WARNING

It is dangerous if the work equipment moves by mistake when the cutting edges and end bits are being reversed or replaced. Set the work equipment in a stable condition, then stop the engine and lock the blade control lever securely with the safety lever.

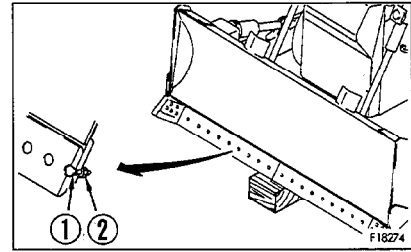

Reverse or replace the end bits and cutting edges before it is worn out to the blade end.

1. Raise the blade to a proper height and apply a block to the frame so as to prevent fall of the blade.
2. Operate the safety lever to the LOCK position.
3. Measure the wear of the end bit and cutting edge in accordance with the wear standards given below.

Wear standards

(Unit: mm)

Item			Judgement standard	
No.	Measurement point	Work equipment	Standard dimension	Repair limit
1	Height of outside of end bit	A	237	204
		B, C	204	187
		D	292	254
		E	237	204
2	Width of end bit	A	325	300
		B, C	325	300
		D	435	410
		E	325	310
3	Height of inside of end bit	A	204	187
		B, C	204	187
		D	254	237
		E	204	187
4	Height of cutting edge (from center of bolt mounting hole to end face)	A	102	85
		B, C	102	85
		D	127	103
		E	102	85

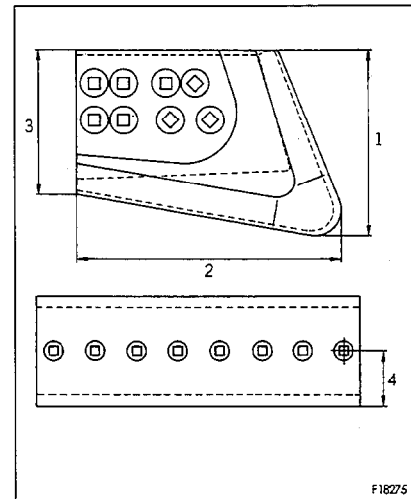

The symbols in the work equipment column have the following meaning.

- A: Straight tiltdozer (D65E/D65EX)
- B: Straight tiltdozer (D65P/D65PX)
- C: Power tilt, power pitch dozer
- D: Semi-U blade
- E: Angledozer

If the cutting edge and the end bit on both sides are worn out, replace with new one.

If it has been worn out up to the fitting surface, repair the fitting surface and then reverse or replace.

4. Remove the cutting edge and the end bit and clean the mounting surface.
5. Reverse or replace the cutting edge and the end bit when worn out.

Nut tightening torque:

- Straight tiltdozer 47 ± 7 kgm
- Power tilt, power pitch dozer 47 ± 7 kgm
- Semi-U blade 47 ± 7 kgm
- Angledozer 45 ± 5 kgm

If bolt ① and nut ② are damaged, replace them with new ones at the same time.

6. After several hours of running, retighten the nuts.

24.1.7 CLEAN, CHECK RADIATOR FINS



WARNING

If compressed air, steam, or water hit your body directly, there is danger of injury. Always wear protective glasses, mask, and safety shoes.

If the radiator fins are clogged or dirty, clean and inspect them.

1. Remove bolts ① (4 bolts).
2. Open the A side (hinge side) of the radiator mask. It opens approx. 10 mm.
3. Leave the B side of the radiator mask open.
4. Clean the radiator fins clogged with mud, dust and leaves with compressed air. Steam or water may be used instead of compressed air.

REMARK

Check the rubber hose. If the hose is found to have cracks to be hardened by ageing, replace such hose with new one. Further, loosen hose clamp should also be checked.

5. When closing the radiator mask, always push in the A side first, then push in the B side, align the bolt holes, and tighten bolt ①.

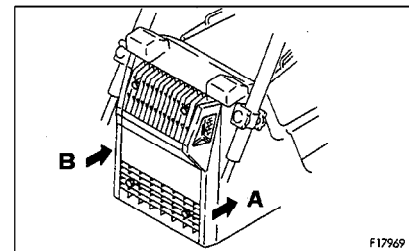
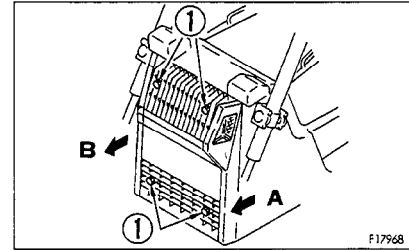

24.1.8 ADJUST IDLER CLEARANCE

Since the idlers are forced to move forward and backward by an external force guide plates ② will be worn out.

Wear of these plates will cause the vibration of idlers from side to side or inclination of the idlers, and running off of track links from the idlers or unevenly worn idler and links may result.

Therefore, adjust the idlers according to the following procedure.

Adjustment

1. Move machine about 1 or 2 meters on a flat ground.
2. Measure the clearance **A** (4 locations: left, right, inside and outside) between the track frame and the guide plate.
3. If the clearance **A** exceeds 4.0 mm, loosen bolt ①, and pull out the shim to adjust the clearance at one end to 0.5 — 1.0 mm.

REMARK

Thickness of one shim is 1.0 mm.

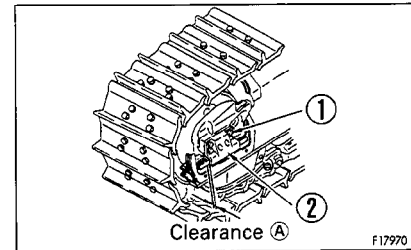

24.1.9 ADJUSTING TENSION OF CENTER BRACE (POWER TILT DOZER ONLY) (POWER TILT, POWER PITCH DOZER ONLY)

When the blade assembly is removed for transportation, the tension of the center brace must be adjusted when the blade is assembled again. If the tension is not adjusted, the bushing at the blade and straight frame mount will come out, and soil will enter. This will result in damage or premature wear of the bushing.

Adjustment

WARNING

Except when operating the blade in Step 4, always lock the blade control lever securely with the safety lever.

- Adjust with shim ② so that the play of ball joint ① is 0.2 – 0.5 mm.
- Loosen bolt ③.
- Install the blade assembly.
- Operate the blade control lever to float the blade.
- Insert a bar in hole ④ in the center brace, and turn it in the direction of protrusion. When doing this, adjust so that clearance D between the track and frame is the same on the left and right sides.
Rotating torque: 2.5 – 5 kgm (Blade at FLOAT)
Standard distance (ℓ) between joints: 995 mm
- Tighten bolt ④.
Tightening torque: 45 ± 5 kgm

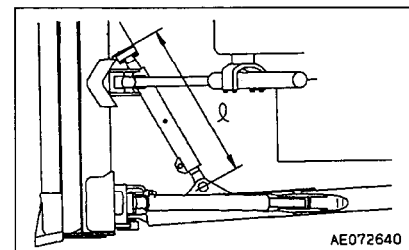
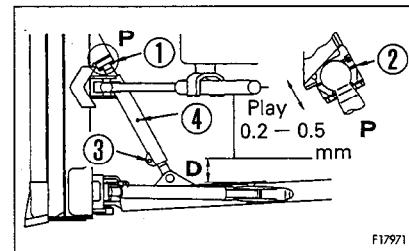

24.1.10 CLEAN AIR CONDITIONER AIR FILTER (FRESH/RECIRC FILTER) (MACHINES EQUIPPED WITH CAB)

If the air conditioner air filter is clogged or there is dirt or dust in it, clean the filter.

1. Open inspection cover ①, remove cover ②, then remove FRESH filter ③.
2. Open inspection cover ④ under the front panel, pull up RECIRC filter ⑤, and remove it.
3. Clean filters ③ and ⑤ with compressed air. If there is oil stuck to the filter, or it is extremely dirty, wash it in a neutral agent. After washing it, dry it completely before installing it again.

If the clogging of the filter cannot be removed by washing or using compressed air, replace the filter with a new part.

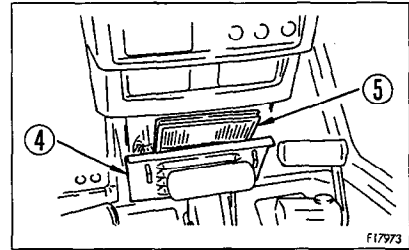
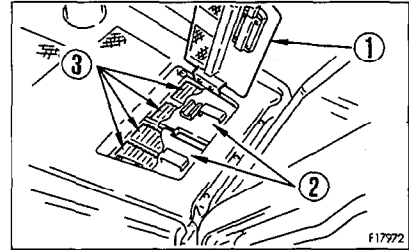

24.1.11 CHECK, ADJUST AIR CONDITIONER (MACHINES EQUIPPED WITH CAB)

CHECKING TENSION OF COMPRESSOR BELT

If the belt is loose, it will slip and the cooling effect will be reduced. From time to time, press a point midway between the drive pulley and compressor pulley with your finger (approx. 10 kg) and check that the tension is 15 – 18 mm.

When the belt is new, there will be initial elongation, so always adjust again after 2 or 3 days.

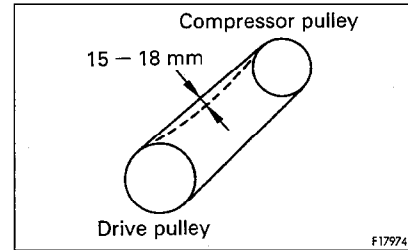

CHECK LEVEL OF REFRIGERANT (GAS)

⚠ WARNING

The refrigerant used in the cooler is colorless and odorless and does not harm the atmosphere, but if the liquid gets into your eyes or on your hands, it may cause loss of sight or frostbite, so never loosen any part of the refrigerant circuit.

If the level of the refrigerant (gas) is low, the cooling effect will be reduced. Run the engine at high idling, and check the flow of the refrigerant in the refrigerant circuit through the sight glass of the receiver when the cooler is running at high speed.

- No bubbles in refrigerant flow: Correct
- Bubbles in refrigerant flow (bubbles continuously pass through): Refrigerant level low
- Colorless, transparent: No refrigerant

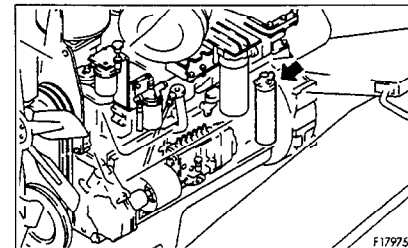

REMARK

When there are bubbles, the refrigerant gas level is low, so contact your refrigerant dealer to have refrigerant added. If the air conditioner is run with the refrigerant gas level low, it will cause damage to the compressor.

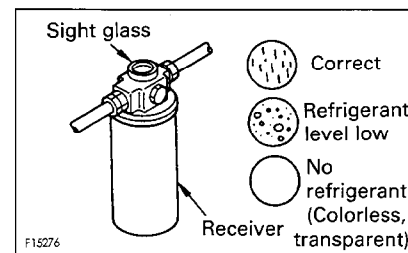

24.1.12 GREASE DOOR HINGE (MACHINES EQUIPPED WITH CAB)

If the door makes a squeaking noise when it is opened or closed, spray lubricant in through the split in the hinge bushing.

If the bushing is worn, replace the hinge.

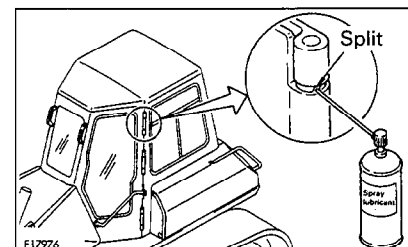

24.1.13 CHECK DOOR LOCK STRIKER (MACHINES EQUIPPED WITH CAB)

If the wear of the doors lock striker exceeds 0.5 mm, replace the striker. If it is used at it is, the play will increase and this may result in breakage of the hinge or door lock.

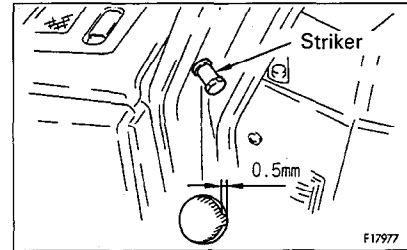

24.1.14 REPLACE DOOR DAMPER (MACHINES EQUIPPED WITH CAB)

If the depth of the door damper rubber groove is less than 2 mm, replace the damper.

There are two dampers each at the top and bottom on the left and right doors.

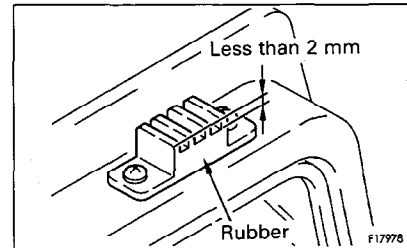

24.1.15 CHECK WINDOW WASHER FLUID LEVEL, ADD FLUID (MACHINES EQUIPPED WITH CAB)

If there is air in the window washer fluid, check the level and add fluid.

Open the engine side cover on the right side, check the level of the fluid in window washer tank ①, and if it is low, add automobile window washer fluid.

When adding fluid, be careful not to let dirt or dust get in.

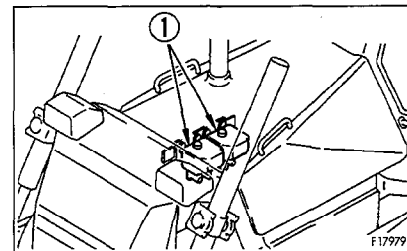

24.1.16 BLEED AIR FROM HEAD END OF RIGHT PITCH CYLINDER (POWER TILT, POWER PITCH DOZER ONLY)

Bleed the air if the work equipment has been removed or repaired.

1. Raise the blade and run the engine at low idling.
2. Operate the left and right tilt 5 – 10 times to bleed the air from the tilt circuit.
3. Operate the forward and rear pitch 5 – 10 times to bleed the air from the bottom end of the right cylinder.
4. Set the left and right cylinders at the neutral position, then carry out the following operations 5 – 10 times to bleed the air from the head end of the right pitch cylinder.

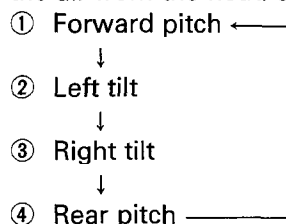

24.1.17 REPLACE WIPER BLADE (MACHINES EQUIPPED WITH CAB)

If the blade is damaged, it will not wipe the window clean, so replace the blade.

Method of replacement

- Front, rear wiper

1. Remove screw ①, then remove the blade.
2. Install a new blade, then tighten screw ① securely.

- Door wiper

1. It is hooked at portion ①, so move the blade in the direction of the arrow to remove it.
2. Install the new blade and hook it securely.

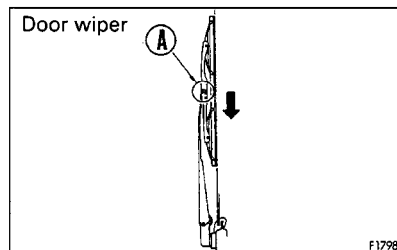
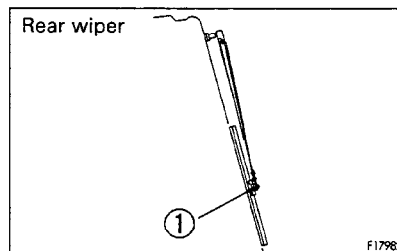
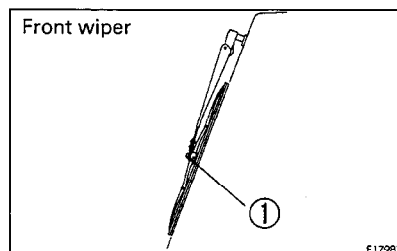
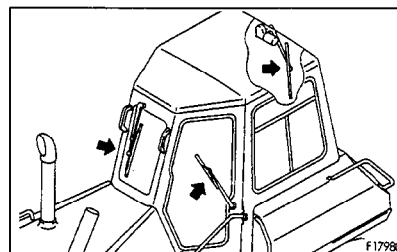

24.1.18 CHECK IDLER OIL LEVEL, ADD OIL

⚠ WARNING

When adding oil, if the machine is at an angle, be careful that it does not turn over. Be careful also when getting on or off the machine. In particular, be sure to use the handrails and steps when getting on or off the machine, and take other precautions to ensure safety.

If the oil level in the idler is low, noise will be generated and there will be seizure, so check the oil level and add oil as follows.

Checking

1. Remove bolt ①, then remove cover ②.
2. Remove bolt ③, then remove guide plate ④ and shim ⑤.

REMARK

When removing shim ⑤ keep it in a safe place and be careful not to lose it.

3. Loosen plug ⑥ and check if oil comes out. If oil comes out the oil level is correct.

If no oil comes out, drive the machine on to a block to tilt the machine. Then remove plug ⑥ and add engine oil through oil filler port ⑦.

For details of the oil to use, see "20. USE OF FUEL, COOLANT AND LUBRICANTS ACCORDING TO AMBIENT TEMPERATURE".

REMARK

If it is difficult to add oil, please contact your Komatsu distributor.

4. After adding oil, install plug ⑥.
5. Install guide plate ④ and shim ⑤ with bolt ③.

REMARK

When installing guide plate ④, install the same number and thickness of shim ⑤ as was removed in Step 2. For details of adjusting the shim thickness, see "24.1.8 ADJUST IDLER CLEARANCE".

6. Install cover ② with bolt ①.

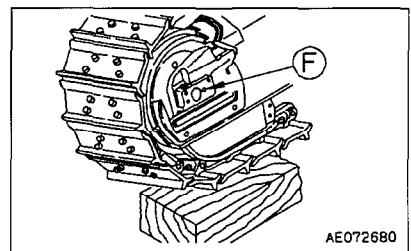
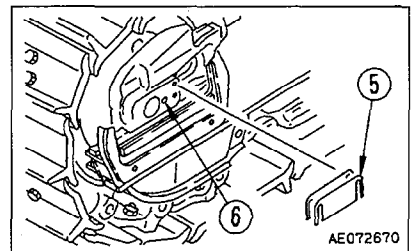
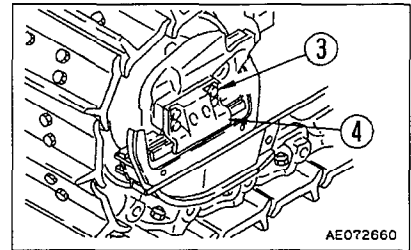
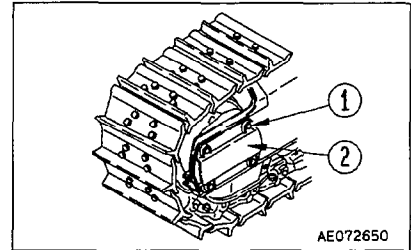

24.2 CHECK BEFORE STARTING

24.2.1 CHECK COOLANT LEVEL, ADD WATER

Always carry out the items in this section before starting the engine each day.

CHECK AND REFILL COOLANT

WARNING

Normally, do not open the radiator cap. When checking the cooling water level, check the sub-tank when the engine is cold.

1. Open the engine side cover on the right side of the chassis, and check that the cooling water is between the FULL and LOW marks on sub-tank ①. If the water level is low, add water to the FULL level through the water filler port in sub-tank ①.

REMARK

In summer, the coolant may overflow from the sub-tank drain hose. This is no problem. It occurs because too much coolant has been added.

2. After adding water, tighten the cap securely.
3. If the sub-tank is empty, check for leakage of water, then add water to the radiator and sub-tank.
4. After adding water, close the engine side cover.

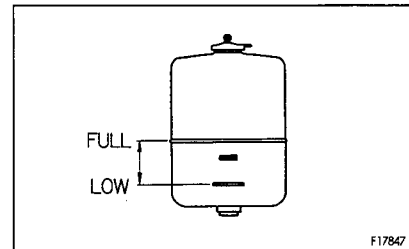
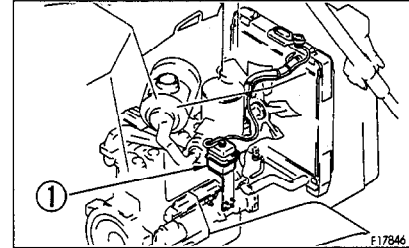

24.2.2 CHECKING WITH MACHINE MONITOR (MONITOR PANEL SPECIFICATION)

1. Turn starting switch ① to the ON position.
2. Check that all monitor lamps light up for 3 seconds, the warning lamp lights up for 2 seconds, and the alarm buzzer sounds for 1 second.

REMARK

- If the lamps do not light up, there may be a failure or disconnection in the monitor, so please contact your Komatsu distributor.
- When carrying out the checks before starting, do not rely only on the monitor. Always carry out all the items listed for periodic maintenance.

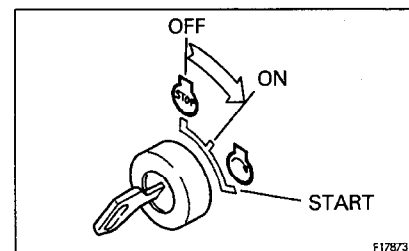
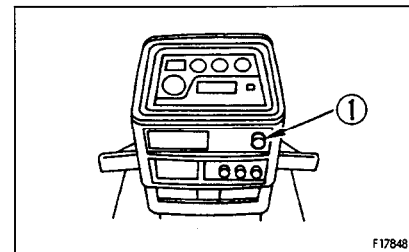

24.2.3 CHECK FUEL LEVEL, ADD FUEL (MONITOR PANEL SPECIFICATION)

⚠ WARNING

When adding fuel, never let the fuel overflow. This may cause a fire. If you spill fuel, thoroughly clean up any spillage.

1. Turn the engine starting switch to the ON position and check the fuel level with fuel level gauge ⑥ on the monitor panel.
After checking, turn the switch back to the OFF position.
2. After completing work, fill the fuel tank through oil filler port ⑦.
For details of the method of opening and closing the cap, see "11.9 CAP WITH LOCK".
For details of the fuel to use, see "20. USE OF FUEL, COOLANT AND LUBRICANTS ACCORDING TO AMBIENT TEMPERATURE".
3. After adding fuel, tighten the cap securely.
Fuel capacity: 340 ℓ

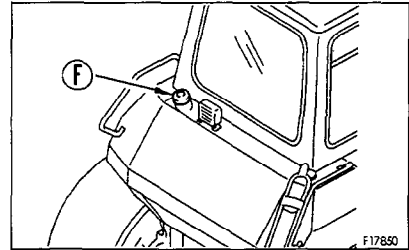
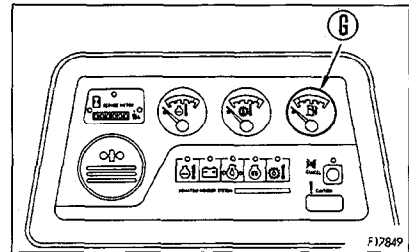

24.2.4 CHECK FUEL LEVEL, ADD FUEL (GAUGE PANEL SPECIFICATION)

⚠ WARNING

When adding fuel, never let the fuel overflow. This may cause a fire. If you spill fuel, thoroughly clean up any spillage.

1. Removed the cap and check the fuel level using fuel gauge ⑥.
For details of the method of opening and closing the cap, see "11.9 CAP WITH LOCK".
2. After completing work, fill the fuel tank through oil filler port ⑦.
For details of the fuel to use, see "20. USE OF FUEL, COOLANT AND LUBRICANTS ACCORDING TO AMBIENT TEMPERATURE".
3. After adding fuel, tighten the cap securely.
Fuel capacity: 340 ℓ

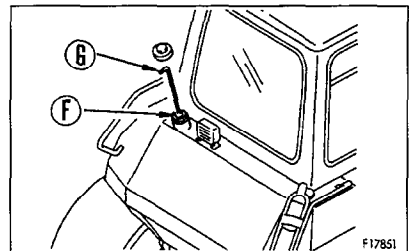

24.2.5 CHECK OIL LEVEL IN ENGINE OIL PAN, ADD OIL

1. Open the engine side cover on the left side of the chassis.
2. Remove dipstick ③ and wipe the oil off with a cloth.
3. Insert dipstick ③ fully in the oil filler pipe, then take it out again.

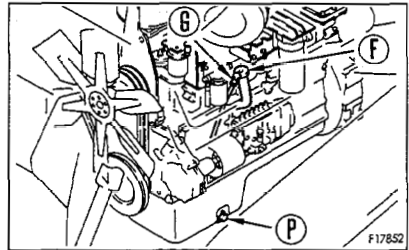

4. The oil level should be between the H and L marks on dipstick ③.
If the oil level is below the L mark, add engine oil through oil filler ④.
For details of the oil to use, see "20. USE OF FUEL, COOLANT AND LUBRICANTS ACCORDING TO AMBIENT TEMPERATURE".
5. If the oil is above the H mark, drain the excess engine oil from drain plug ⑤, and check the oil level again.
6. If the oil level is correct, tighten the oil filler cap securely and close the engine side cover.

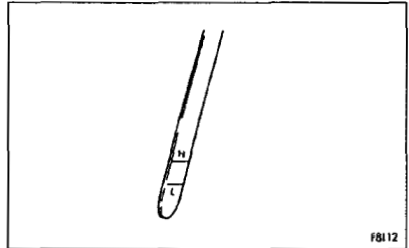





REMARK

When checking the oil level after the engine has been operated, wait for at least 15 minutes after stopping the engine before checking.

If the machine is at an angle, make it horizontal before checking.

24.2.6 CHECK OIL LEVEL IN POWER TRAIN CASE, ADD OIL

1. Remove dipstick , and wipe the oil off with a cloth.
2. Insert dipstick  fully in the oil filler pipe, then take it out again.
3. The oil level should be between the H and L marks on dipstick .
If the oil level is below the L mark, add engine oil through oil filler .
For details of the oil to use, see "20. USE OF FUEL, COOLANT AND LUBRICANTS ACCORDING TO AMBIENT TEMPERATURE".
4. If the oil is above the H mark, drain the excess engine oil from drain plug , and check the oil level again.
5. If the oil level is correct, tighten the oil filler cap securely.

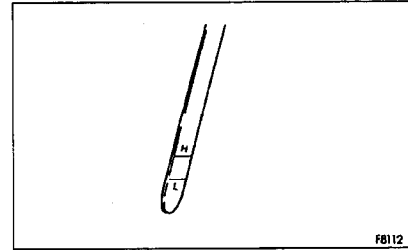
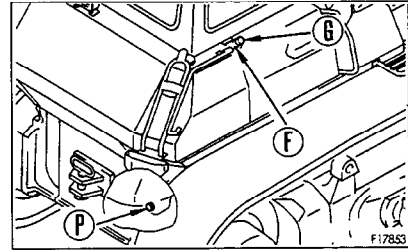

REMARK



- When stopping the engine, check the oil level.
- When checking the oil level after the engine has been operated, wait for at least 15 minutes after stopping the engine before checking.
If the machine is at an angle, make it horizontal before checking.

24.2.7 CHECK BRAKE PEDAL TRAVEL

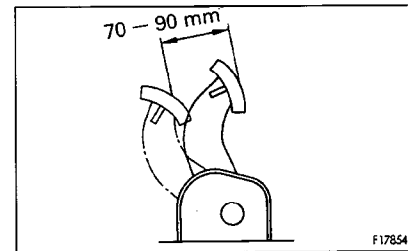
1. Depress the brake pedal all the way until it stops.
2. The distance of travel at the center of the pedal (position in the diagram on the right) should be 70 – 90 mm.
3. When this value exceeds 90 mm, or the brake fails to work, please contact your Komatsu distributor for adjustment.



24.2.8 CHECK DUST INDICATOR

1. Open the engine side cover on the left side of the chassis, and check that the red piston has not appeared in the transparent portion of dust indicator .
2. If the red piston has appeared, clean or replace the element immediately.
For details of the method of cleaning the element, see "24.1 WHEN REQUIRED".
3. After checking, cleaning, and replacing, press the knob of dust indicator  to return the red piston to its original position.

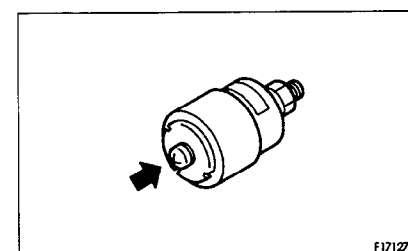
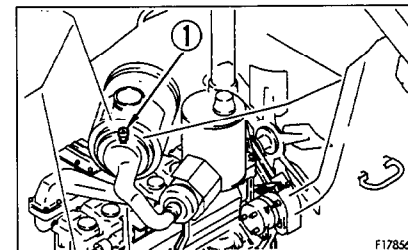

24.2.9 CHECK THAT LAMPS LIGHT UP

Turn the head lamp switch, the rear lamp switch and the additional working lamp to the ON position and check that the head lamps and rear lamps light up.

If the lamps do not light up, there is probably a broken bulb or disconnection in the wiring, so contact your Komatsu distributor for repairs.

24.2.10 CHECK HORN SOUND

24.2.11 CHECK BACKUP ALARM SOUND

24.2.12 CHECK SEAT BELT FOR WEAR OR DAMAGE

Check the belt and mounting clamps, and if they are worn or damaged, replace the seat belt.

24.2.13 CHECK FOR WATER AND SEDIMENT IN WATER SEPARATOR, DRAIN WATER

The water separator separates water mixed in the fuel. If float ② is at or above red line ①, drain the water according to the following procedure:

1. Loosen drain plug ③ and drain the accumulated water until the float reaches the bottom.
2. Tighten drain plug ③.
3. If the air is sucked into fuel line when draining and water, be sure to bleed air in the same manner as for the fuel filter. See "24.5 EVERY 500 HOURS SERVICE".

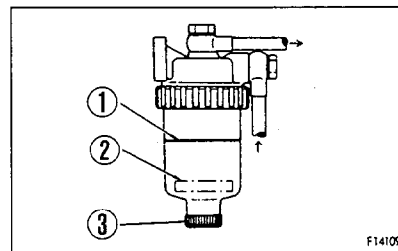

24.3 EVERY 50 HOURS SERVICE

24.3.1 DRAIN WATER, SEDIMENT FROM FUEL TANK

Open the inspection cover at the bottom of the fuel tank, loosen valve ①, and drain the fuel together with the water and sediment accumulated at the bottom of the tank.

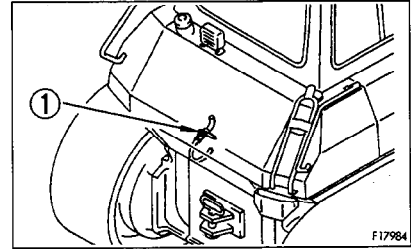

24.4 EVERY 250 HOURS SERVICE

Maintenance for the 50 hours service should be carried out at the same time.

24.4.1 LUBRICATING

1. Lower the work equipment to the ground, then stop the engine.
2. Using a grease pump, pump in grease through the grease fittings shown by arrows.
3. After greasing, wipe off any old grease that was pushed out.

- Power tilt dozer

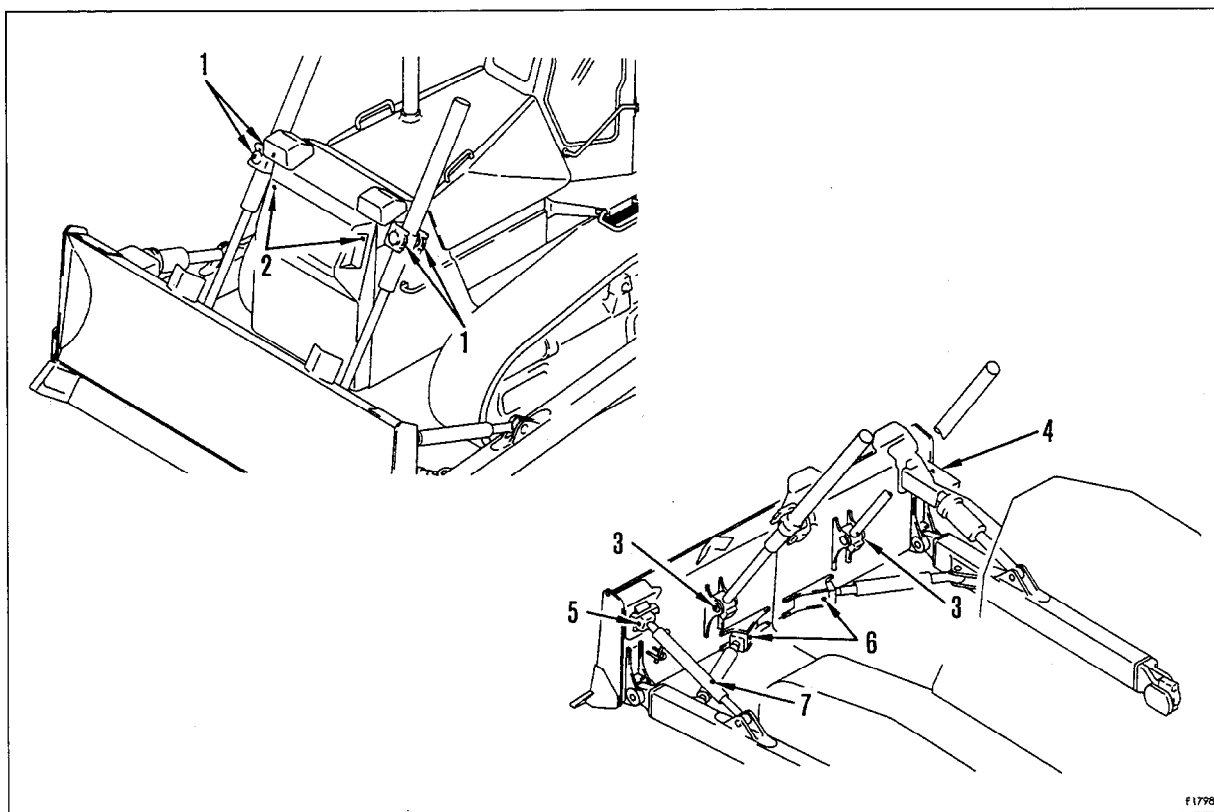

1. Lift cylinder support yoke (4 places)
2. Lift cylinder support shaft (2 places)
3. Lift cylinder ball joint (2 places)
4. Tilt cylinder ball joint (1 place)
5. Tilt brace ball joint (1 place)
6. Brace ball joint (2 places)
7. Tilt brace thread (1 place)

- Power tilt power pitch dozer

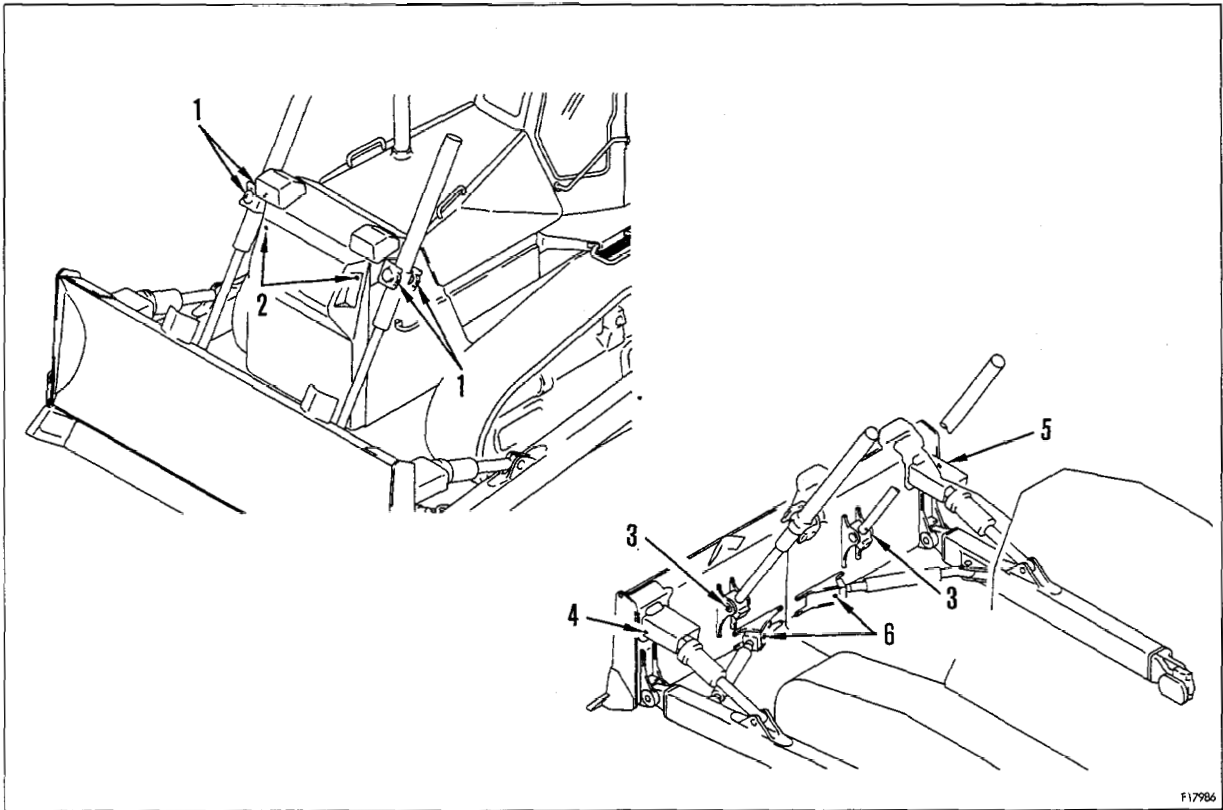

1. Lift cylinder support yoke (4 places)
2. Lift cylinder support shaft (2 places)
3. Lift cylinder ball joint (2 places)
4. Tilt cylinder ball joint (1 place)
5. Pitch cylinder ball joint (1 place)
6. Brace ball joint (2 places)

• Angledozer

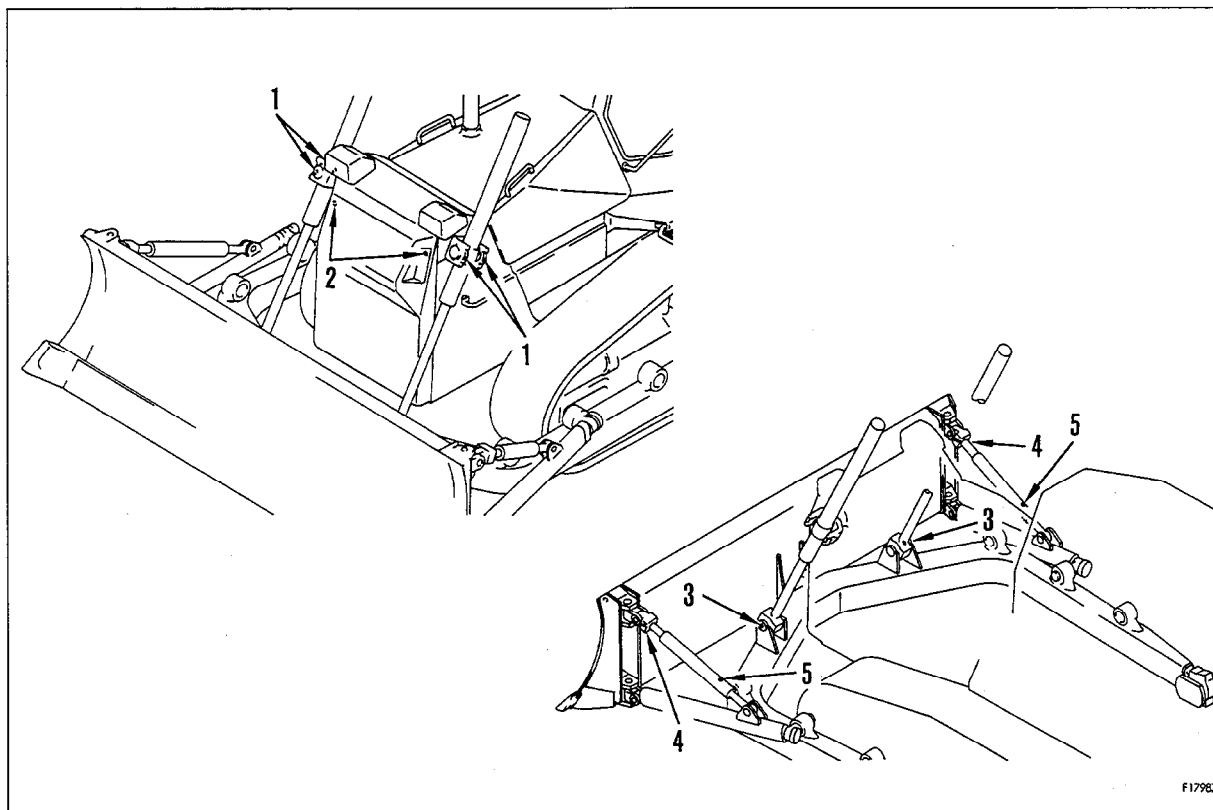

1. Lift cylinder support yoke (4 places)
2. Lift cylinder support shaft (2 places)
3. Lift cylinder ball joint (2 places)
4. Tilt brace ball joint (2 places)
5. Tilt brace thread (2 places)

24.4.2 GREASE EQUALIZER BAR SIDE PIN (LEFT AND RIGHT, 2 PLACES EACH: TOTAL 4 PLACES)

1. Remove cover ①.

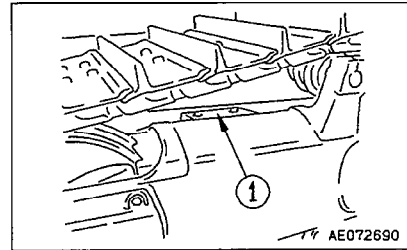

2. Add grease to the grease fittings marked by the arrows.

REMARK

When adding grease, pump in three shots (pump the grease gun lever three times) for each fitting, and check that grease is newly discharged from the seal lip.

If no grease is newly discharged from the seal lip, continue to pump in grease until grease is discharged.

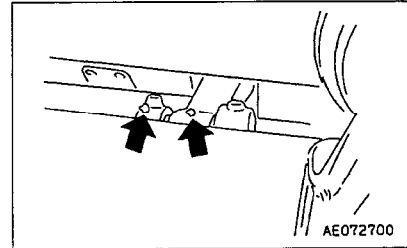

3. Install the cover.

24.4.3 CHECK OIL LEVEL IN FINAL DRIVE CASE, ADD OIL

⚠ WARNING

The oil is at high temperature immediately after the machine has been operated. Wait for the oil to cool down before starting the operation.

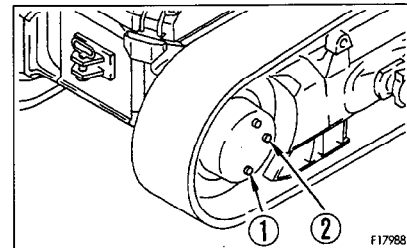

1. Stop the machine so that drain plug ① is directly at the bottom.
2. Remove oil level plug ② and check whether the final drive case is filled with oil to lower edge of the plug hole.
3. If the oil level is still too low, add engine oil through the plug hole until the oil overflows.
For details of the oil to use, see "20. USE OF FUEL, COOLANT AND LUBRICANTS ACCORDING TO AMBIENT TEMPERATURE".

24.4.4 CHECK OIL LEVEL IN HYDRAULIC TANK, ADD OIL

⚠ WARNING

- When removing the oil filler cap, oil may spurt out, so stop the engine and wait for the oil temperature to go down, then turn the cap slowly to release the internal pressure before removing the cap.
- If oil has been added to above the H mark, stop the engine and wait for the hydraulic oil to cool down, then drain the excess oil from the drain plug.

NOTICE

Do not add oil if the level is above the H line. This will damage the hydraulic equipment and cause the oil to spurt out.

1. Lower the blade to the ground, stop the engine and wait for about 5 minutes before checking oil level. If oil level is between H and L in sight gauge ⑥.
2. If the level is below the L mark, add engine oil through oil filler ⑤.

For details of the oil to use, see "20. USE OF FUEL, COOLANT AND LUBRICANTS ACCORDING TO AMBIENT TEMPERATURE".

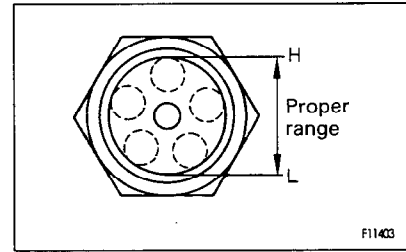
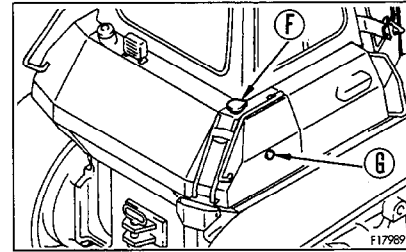

24.4.5 CHANGE OIL IN ENGINE OIL PAN, REPLACE ENGINE OIL FILTER CARTRIDGE (D60P, 65EX, PX ONLY)

⚠ WARNING

The oil is at high temperature after the engine has been operated, so never change the oil immediately after finishing operations. Wait for the oil to cool down before changing it.

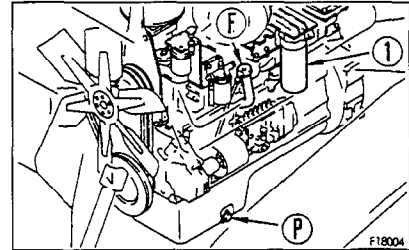

⚠ WARNING

When draining the oil, do not remove drain plug **P**.

Prepare the following.

- Container to catch drained oil: Min 38 ℓ capacity
 - Refill capacity: 38 ℓ
 - Socket wrench, filter wrench.
1. Remove the cover at the bottom of the machine and set a container to catch the oil under the drain plug.
 2. Loosen drain plug **P** (with a slit) slowly to avoid getting oil on yourself, and drain the oil.
 3. Check the drained oil, and if there are excessive metal particles or foreign material, please contact your Komatsu distributor.
 4. Install drain plug **P**.
 5. Using a filter wrench, turn filter cartridge **1** counterclockwise to remove it. When doing this, to prevent getting oil on yourself, do not carry out this operation from immediately under the cartridge.
In particular, if this operation is carried out immediately after stopping the engine, a large amount of oil will come out, so wait for 10 minutes before starting the operation.
 6. Clean the filter holder, coat the packing surface of a new filter cartridge with engine oil (or coat it thinly with grease), then install it to the filter holder.

Before installing a filter cartridge, be sure to fill the cartridge with engine oil.

7. When installing, tighten until the packing surface contacts the seal surface of the filter holder, then tighten it up 3/4 to 1 of a turn.
8. After replacing the filter cartridge, add engine oil through oil filler Ⓢ until the oil level is between the H and L marks on the dipstick.
For details of the oil to use, see "20. USE OF FUEL, COOLANT AND LUBRICANTS ACCORDING TO AMBIENT TEMPERATURE".
9. Run the engine at idling for a short time, then stop the engine, and check that the oil level is between the H and L marks on the dipstick. For details, see "24.2 CHECK BEFORE STARTING".

NOTICE

Even if the machine has not been operated for 250 hours, the oil and filter cartridge must be replaced when the machine has been operated for 6 months.

In the same way, even if the machine has not been operated for 6 months, the oil and filter cartridge must be replaced when the machine has been operated for 250 hours.

24.4.6 CHECK LEVEL OF BATTERY ELECTROLYTE

Carry out this check before operating the machine.



WARNING

- To avoid gas explosions, do not bring fire or sparks near the battery.
- Battery electrolyte is dangerous. If it gets in your eyes or on your skin, wash it off with large amounts of water, and consult a doctor.

1. Open the battery cover.
2. Remove cap ①, and check that the electrolyte is at the specified level (10 to 12 mm above the plate). If the electrolyte level is low, add distilled water to the specified level. If the battery electrolyte is spilled, have dilute sulphuric acid added.
3. When adding distilled water to any cell at cap ①, add distilled water also to the other cells.
4. Clean the air hole in the battery cap, then tighten the cap securely.

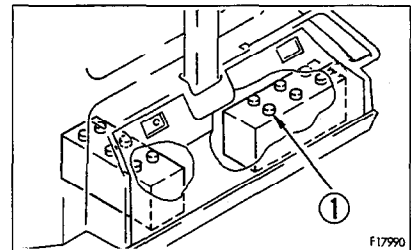

NOTICE

When adding distilled water in cold weather, add it before starting operations in the morning to prevent the electrolyte from freezing.

24.4.7 CHECK FAN BELT TENSION, ADJUST

Checking

The belt should normally deflect by 6 – 10 mm when pressed with the finger (with a force of approx. 6 kg) at a point midway between the alternator pulley and fan pulley.

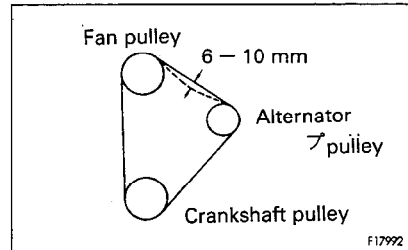
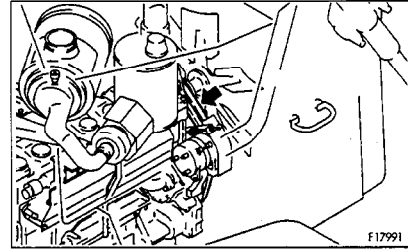

Adjusting

1. Loosen bolts and nuts ①, ② and ③.
2. Turn nut ④ clockwise, then move alternator ⑤ to adjust the belt tension so that the deflection is approx. 6 mm when pushed with a force of 6 kg.
3. Tighten the bolts and nuts ①, ② and ③ to fix alternator ⑤ in position.
4. Check each pulley for damage, wear of the V-groove, and wear of the V-belt. In particular, be sure to check that the V-belt is not touching the bottom of the V-groove.
5. If any belt has stretched and there is no allowance for adjustment, or if there are cuts or cracks on any belt, replace both belts at the same time.
6. When the new belt is set, readjust it after operation for an hour.

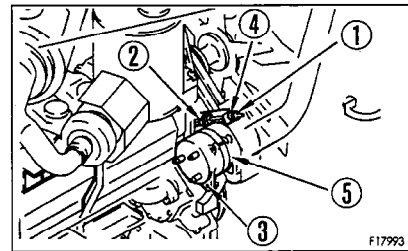

24.4.8 DRAIN WATER AND SEDIMENT FROM FUEL FILTER

1. Open the engine side cover on the left side, loosen drain plug ① at the bottom of the filter, and drain the fuel together with the water and sediment accumulated at the bottom of the tank.
2. Tighten drain plug ①.
3. Loosen the knob of feed pump ② and operate it 50 – 60 times up and down. This will bleed the air.
4. Push in the knob of feed pump ② and tighten it.

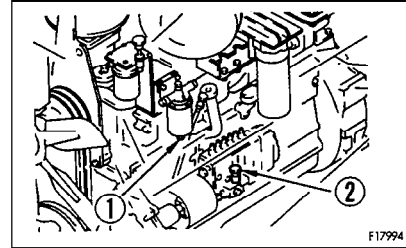

24.4.9 CHECK, CLEAN ADDITIONAL FUEL STRAINER

1. Open the inspection cover at the bottom of the fuel tank.
2. Tighten the fuel supply valve, then remove the cap, and clean the strainer and strainer case. The strainer forms one unit with the cap.
3. Set the strainer in the case, then tighten the cap.
4. After installing, open the fuel supply valve.

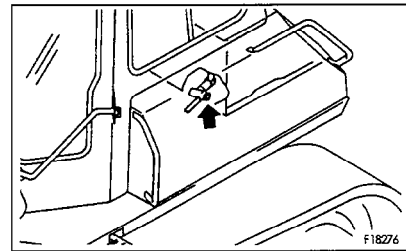

24.4.10 REPLACE POWER TRAIN OIL FILTER ELEMENT

1. Remove top mounting bolts ② of filter cover ①, then use the bottom hinge as the fulcrum to open the cover to the outside.

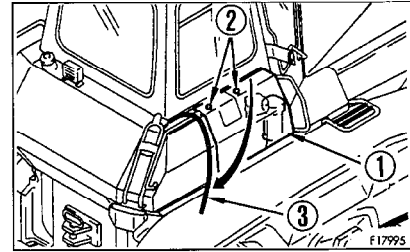

2. Remove seal ③ installed to the frame.

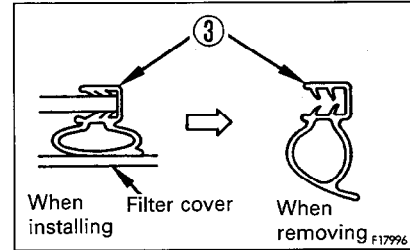

3. Remove mounting bolt ⑤ of filter ④, then remove cover ⑥.

4. Remove the grommet under the fender, loosen drain plug ⑰, and drain the oil inside the filter case.

5. Take out element ⑦.

6. Clean the removed parts and the inside of the case, then install a new element.

Set so that the side hole of cover ⑥ is in the direction to match hole ① of filter case ④, then tighten with bolt ⑤.

7. Install drain plug ⑰.

8. After installing, loosen air bleed plug ⑧, start the engine, and when oil spurts out, tighten the plug.

9. Close filter cover ①, and tighten bolt ②.

10. Install frame seal ③.

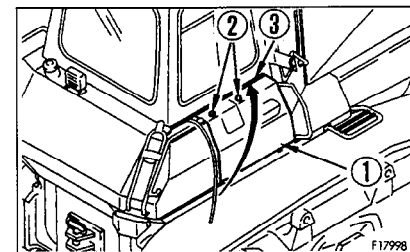
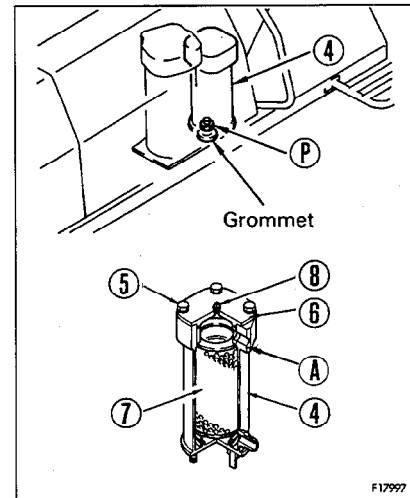

NOTICE

When installing seal ③, always close filter cover ① first.
If the filter cover is closed after the seal is installed, the seal will be damaged.

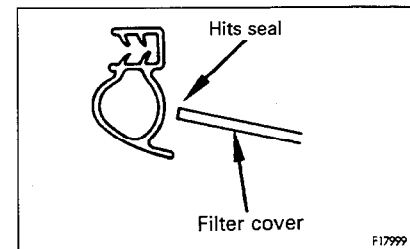

24.4.11 CHECK BRAKE CAPACITY

WARNING

If the machine moves during the following operation, please contact your Komatsu distributor for repairs immediately.

Before starting the engine, check that the area around the machine is safe, then do as follows.

1. Start the engine.
2. Set safety lever ① in the FREE position, operate blade control lever ②, and raise the blade.
Leave the safety lever in the FREE position.
3. Set brake lock lever ③ in the FREE position.
4. Depress brake pedal ④ and set gearshift lever ⑤ in 2nd.

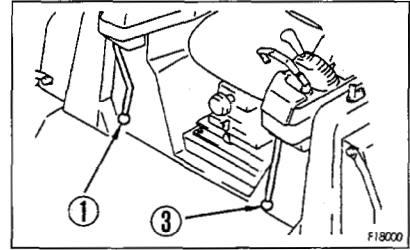

NOTICE

Never place the gearshift lever in 1st. This will damage the machine.

5. Operate fuel control lever **h** and gradually raise the engine speed to high idling.
6. If the machine does not move when the above operation is carried out, the brake is normal.

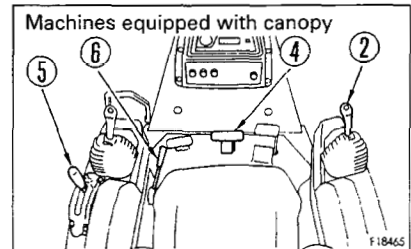
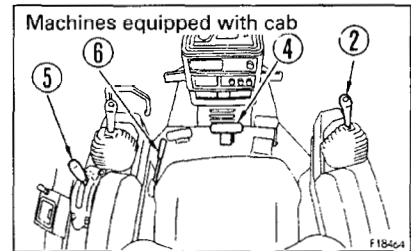

24.5 EVERY 500 HOURS SERVICE

Maintenance for every 50 and 250 hours should be carried out at the same time.

24.5.1 REPLACE FUEL FILTER CARTRIDGE

⚠ WARNING

- Engine is at high temperature immediately after the machine has been operated. Wait for engine to cool down before replacing the filter.
- Do not bring fire or sparks near the fuel.

Prepare a filter wrench and a container to catch the fuel.

1. Set the container to catch the fuel under the filter cartridge.
2. Using a filter wrench, turn filter cartridge ① counterclockwise to remove it.
3. Clean the filter holder, fill a new filter cartridge with clean fuel, coat the packing surface with engine oil, then install it to the filter holder.
4. When installing, tighten until the packing surface contacts the seal surface of the filter holder, then tighten it up 1/2 to 3/4 of a turn.
If the filter cartridge is tightened too far, the packing will be damaged and this will lead to leakage of fuel. If the filter cartridge is too loose, fuel will also leak from the packing, so always tighten to the correct amount.
5. Loosen the knob of feed pump ② and operate it 50 — 60 times up and down. This will bleed the air.
6. Push in the knob of feed pump ② and tighten it.

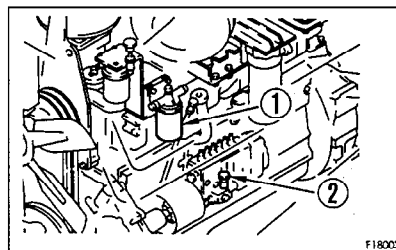

7. After replacing the filter cartridge, start the engine and check that there is no leakage of fuel from the filter seal surface. If there is any leakage of fuel, check the tightening of the filter cartridge. Whenever there is leakage of fuel, follow Steps 1 and 2 to remove the filter cartridge, then check the packing surface for damage or foreign material. If any damage or foreign material is found in the packing, replace the packing with a new part, then repeat Steps 3 – 6 to install the filter cartridge.

- **Method of using automatic air bleed mechanism**

**WARNING**

When cranking the engine, confirm the safety around the engine, as the engine may start.

It is possible to bleed the air from the fuel circuit simply by rotating the starting motor with the starting switch. Bleed the air as follows.

1. After replacing the filter cartridge, check that the fuel control lever is at the low idling position.
2. Place the parking lever to the lock position.
3. Turn the starting switch key to the START position and rotate the starting motor for 15 – 20 seconds to crank the engine and bleed the air.

NOTICE

When the engine has run out of fuel, carry out the same procedure and crank the engine for 15 – 20 seconds. Repeat this operation 2 – 3 times to bleed the air.

Do not rotate the starting motor continuously for more than 20 seconds. Wait for 1 – 2 minutes before rotating again.

The time taken to bleed the air is shorter when the fuel tank is full.

24.5.2 CHANGE OIL IN ENGINE OIL PAN, REPLACE ENGINE OIL FILTER CARTRIDGE (D65E ONLY)

WARNING

The oil is at high temperature after the engine has been operated, so never change the oil immediately after finishing operations. Wait for the oil to cool down before changing it.

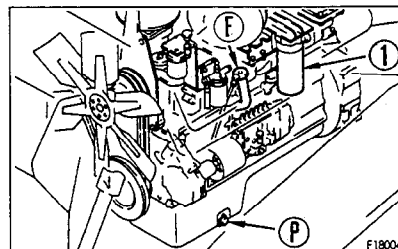



CAUTION

When draining the oil, do not remove drain plug .

Prepare the following.

- Container to catch drained oil: Min 38 ℓ capacity
- Refill capacity: 38 ℓ
- Socket wrench, filter wrench.

1. Remove the cover at the bottom of the machine and set a container to catch the oil under the drain plug.
2. Loosen drain plug  (with a slit) slowly to avoid getting oil on yourself, and drain the oil.
3. Check the drained oil, and if there are excessive metal particles or foreign material, please contact your Komatsu distributor.
4. Install drain plug .
5. Using a filter wrench, turn filter cartridge  counterclockwise to remove it. When doing this, to prevent getting oil on yourself, do not carry out this operation from immediately under the cartridge.
In particular, if this operation is carried out immediately after stopping the engine, a large amount of oil will come out, so wait for 10 minutes before starting the operation.
6. Clean the filter holder, coat the packing surface of a new filter cartridge with engine oil (or coat it thinly with grease), then install it to the filter holder.

Before installing a filter cartridge, be sure to fill the cartridge with engine oil.

7. When installing, tighten until the packing surface contacts the seal surface of the filter holder, then tighten it up 3/4 to 1 of a turn.
8. After replacing the filter cartridge, add engine oil through oil filler \ominus until the oil level is between the H and L marks on the dipstick.
For details of the oil to use, see "20. USE OF FUEL, COOLANT AND LUBRICANTS ACCORDING TO AMBIENT TEMPERATURE".
9. Run the engine at idling for a short time, then stop the engine, and check that the oil level is between the H and L marks on the dipstick. For details, see "24.2 CHECK BEFORE STARTING".

NOTICE

Even if the machine has not been operated for 500 hours, the oil and filter cartridge must be replaced when the machine has been operated for 6 months.

In the same way, even if the machine has not been operated for 6 months, the oil and filter cartridge must be replaced when the machine has been operated for 500 hours.

24.6 EVERY 1000 HOURS SERVICE

Maintenance for every 50, 250 and 500 hours should be carried out at the same time.

24.6.1 CHANGE OIL IN POWER TRAIN CASE, CLEAN STRAINERS (POWER TRAIN STRAINER, SCAVENGING PUMP STRAINER)

⚠ WARNING

- The oil is at high temperature immediately after the machine has been operated. Wait for the oil to cool down before starting the operation.
- The undercover is heavy.
Never try to open or close the cover when directly beneath it. When removing bolts ②, carry out the work from the rear below the cover so that you can easily get out of the way.

Prepare the following.

- Container to catch drained oil: Min 50 ℓ capacity
- Refill capacity: 50 ℓ

1. Loosen drain plug ① (with a slit), drain the oil, then tighten drain plug ① again.
Do not remove drain plug ①.
2. Remove the undercover at the bottom rear of the machine as follows.
 - (1) Remove 2 bolts ① at the front of the machine.
 - (2) Support the cover with your elbow while gradually removing 2 bolts ② at the rear of the machine.
 - (3) Lower the cover gradually to open it.
3. Loosen mounting bolt ③ of the power train strainer, then remove cover ④
4. Take out spring ⑤, then take out strainer ⑥.

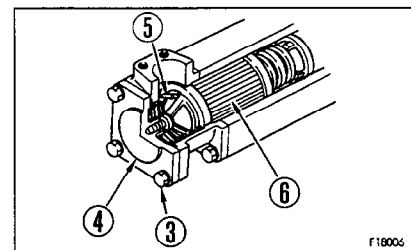
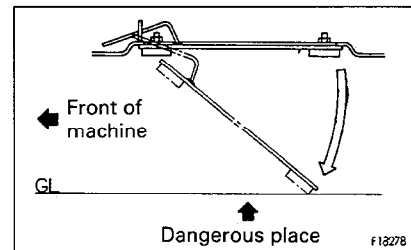
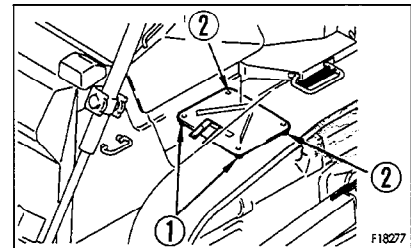
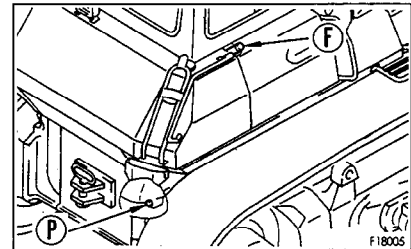

5. Remove all dirt from strainer ⑥, then wash in clean diesel oil or flushing oil.
Clean the case interior and the removed parts.

6. Loosen mounting bolt ⑦ of the scavenging pump strainer, then remove cover ⑧.

7. Take out spring ⑨, then take out strainer ⑩.

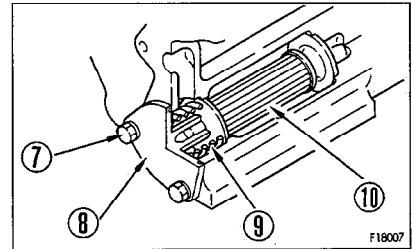

8. Remove all dirt from strainer ⑩, then wash in clean diesel oil or flushing oil.
Clean the case interior and the removed parts.

9. Install the strainers to their original position.

10. After installing, replace the element in the power train oil filter.
For details, see "24.4 EVERY 250 HOURS SERVICE".

11. Refill the specified quantity of engine oil through oil filler ⑤.
For details of the oil to use, see "20. USE OF FUEL, COOLANT AND LUBRICANTS ACCORDING TO AMBIENT TEMPERATURE".

12. Check that the oil is at the specified level.
For details, see "24.2 CHECK BEFORE STARTING".

If the spring or strainer are damaged, replace them.

24.6.2 CHANGE OIL IN FINAL DRIVE CASE

⚠ WARNING

The oil is at high temperature immediately after the machine has been operated. Wait for the oil to cool down before starting the operation.

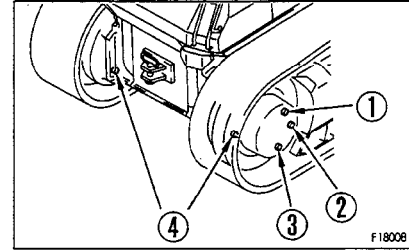

Prepare the following.

- Container to catch drained oil: Min. 30 ℓ capacity
 - Refill capacity
D65E, EX-12: each 24 ℓ
D65P, PX-12: each 27 ℓ
1. Stop the machine so that drain plug ③ is directly at the bottom.
 2. Remove oil level plug ② and oil filler plug ①, then remove drain plugs ③ and ④, and drain the oil. After draining the oil, tighten the plugs.
 3. Add engine oil to the specified level through the hole in oil filler plug ①.
For details of the oil to use, see "20. USE OF FUEL, COOLANT AND LUBRICANTS ACCORDING TO AMBIENT TEMPERATURE".
 4. Check that the oil is at the specified level.
For details, see "24.4 EVERY 250 HOURS SERVICE".

24.6.3 CLEAN BREATHER

Remove the breather and wash out dust remaining inside with diesel oil and flushing oil.

1. Power train (transmission) case breather (1 place)

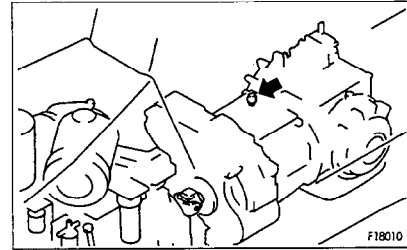

24.6.4 GREASE UNIVERSAL JOINT

Apply grease to the grease fittings (2 places) shown by arrows.

WARNING

The undercover is heavy. Never try to open or close the cover when directly beneath it. When removing bolts ②, carry out the work from the rear below the cover so that you can easily get out of the way.

Remove the undercover at the bottom rear of the machine as follows.

- (1) Remove 2 bolts ① at the front of the machine.
- (2) Support the cover with your elbow while gradually removing 2 bolts ② at the rear of the machine.
- (3) Lower the cover gradually to open it.

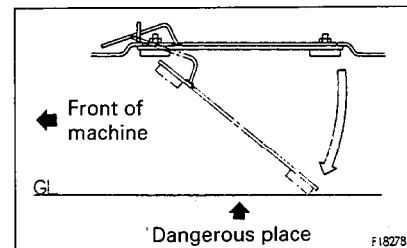
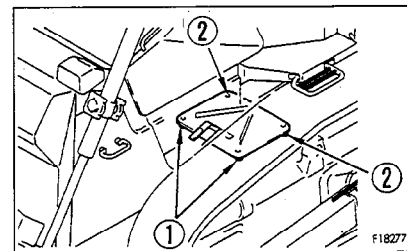
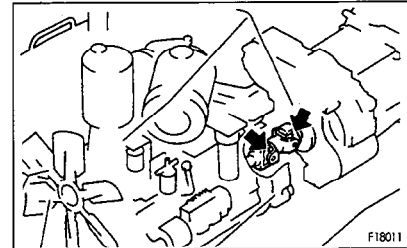

24.6.5 REPLACE CORROSION RESISTOR CARTRIDGE (D65P, D65EX, PX ONLY)

1. Screw in valve ① at the top of the corrosion resistor.
2. Using a filter wrench, turn cartridge ② to the left, and remove it.
3. Coat the seal surface of the new cartridge with engine oil, then install it to the filter holder.
4. When installing, bring the packing surface into contact with the seal surface of the filter holder, then tighten approx. 2/3 turns.
5. Open valve ①.
Always use a genuine Komatsu cartridge.

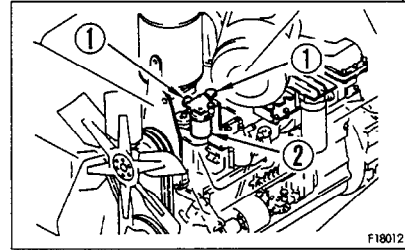

24.6.6 CHECK ALL TIGHTENING PARTS OF TURBOCHARGER (D65P, D65EX, PX ONLY)

Contact your Komatsu distributor to have the tightening portions checked.

24.6.7 CHECK PLAY OF TURBOCHARGER ROTOR (D65P, D65EX, PX ONLY)

Contact your Komatsu distributor to have the play checked.

24.6.8 CHECK FOR LOOSE ROPS MOUNT BOLTS

Check for loose and damaged bolts. If any loose bolt is found, tighten to a torque of 94.5 ± 10.5 kgm.

If any damaged bolt is found, replace the bolt with a genuine Komatsu bolt.

24.7 EVERY 2000 HOURS SERVICE

Maintenance for every 50, 250, 500 and 1000 hours should be carried out at the same time.

24.7.1 CHANGE OIL IN HYDRAULIC TANK, REPLACE HYDRAULIC OIL FILTER ELEMENT

WARNING

The oil is at high temperature immediately after the machine has been operated. Wait for the oil to cool down before changing the oil. When removing the oil filler cap, turn it slowly to release the internal pressure, then remove it carefully.

Prepare the following.

- Container to catch drained oil: Min. 55 ℓ capacity
- Refill capacity: 55 ℓ

1. Lower the blade on the ground securely, stop the engine and slowly turn the cap of oil filler **F** to release the internal pressure. Then, remove the cap.
2. Remove the cover at the bottom of the hydraulic tank.
3. Remove cap **1**, loosen drain valve **2** to drain the oil, then tighten valve **2** again. After tightening, install the cover. When loosening drain valve **2**, be careful not to get the oil on you.
4. Remove the grommet under the fender, loosen drain plug **3**, and drain the oil.
5. Remove top mounting bolts **5** of filter cover **4**, then use the bottom hinge as the fulcrum to open the cover to the outside.
6. Remove seal **6** installed to the frame.

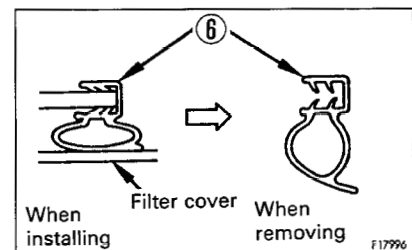
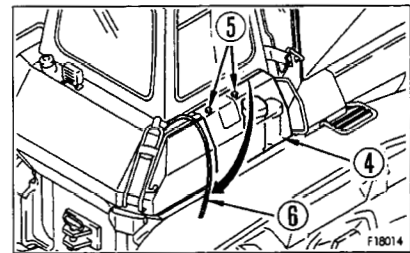
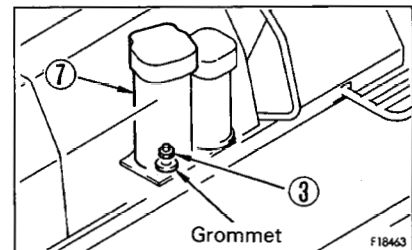
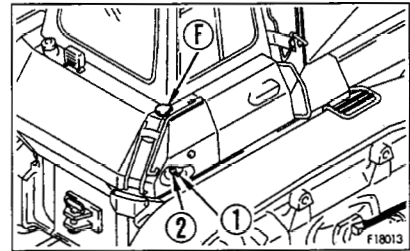

7. Remove mounting bolt ⑧ of filter ⑦, then remove cover ⑨.

8. Take out element ⑩.

9. Clean the removed parts and the inside of the case, then install a new element.
Always use a genuine Komatsu element.

10. Install drain plug ③.

11. After installing, loosen air bleed plug ⑪, start the engine, and when oil spurts out, tighten the plug.

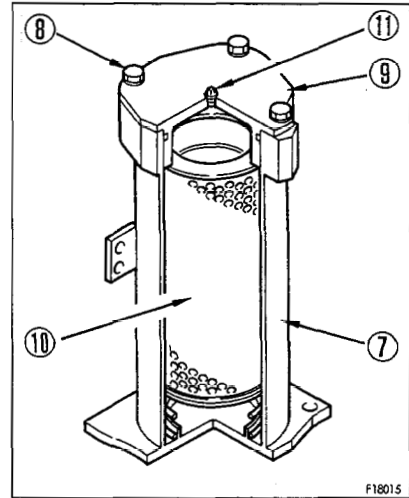

12. Close filter cover ④, and tighten bolt ⑤.

13. Install frame seal ⑥.

NOTICE

**When installing seal ⑥, always close filter cover ④ first.
If the filter cover is closed after the seal is installed, the seal will be damaged.**

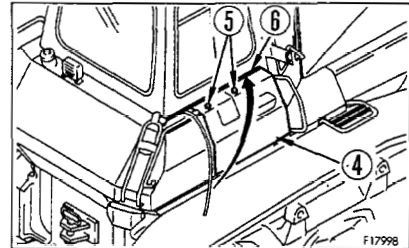

14. Add the specified amount of engine oil through the oil filler ㉞.

For details of the oil to use, see "20. USE OF FUEL, COOLANT AND LUBRICANTS ACCORDING TO AMBIENT TEMPERATURE".

15. Check that the oil is at the specified level. For details, see "24.4 EVERY 250 HOURS SERVICE."

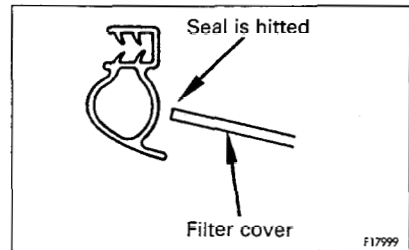

24.7.2 CLEAN, CHECK TURBOCHARGER (D65P, D65EX, PX ONLY)

Contact your Komatsu distributor for cleaning or inspection.

24.7.3 CLEAN ENGINE BREATHER ELEMENT

1. Wipe off all the dirt around the breather on the cam follower cover.
2. Remove the breather.
3. Wash the whole breather in diesel oil or flushing oil, then blow it dry with compressed air.
4. Replace the breather O-ring with a new part, coat with engine oil, and install it.

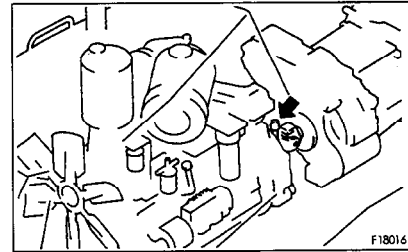

24.7.4 CHECK VIBRATION DAMPER

Check that there are no cracks or peeling in the outside surface of the rubber.

If any cracks or peeling are found, contact your Komatsu distributor to have the parts replaced.

24.7.5 CHECK ALTERNATOR, STARTING MOTOR

The brush may be worn, or the bearing may have run out of grease, so contact your Komatsu distributor for inspection or repair.

If the engine is started frequently, carry out inspection every 1000 hours.

24.7.6 CHECK ENGINE VALVE CLEARANCE, ADJUST

Contact your Komatsu distributor for inspection or adjustment.

24.8 EVERY 4000 HOURS SERVICE

Maintenance for every 50, 250, 500, 1000 and 2000 hours should be carried out at the same time.

24.8.1 CHECK WATER PUMP

Check that there is oil leakage, water leakage, or clogging of the drain hole. If any abnormality is found, contact your Komatsu distributor for disassembly and repair or replacement.

SPECIFICATIONS

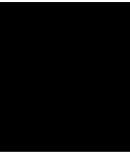

25. SPECIFICATIONS

	D65E-12	D65P-12	D65EX-12	D65PX-12
OPERATING WEIGHT (with operator)				
With steel cab and ROPS canopy	18375* kg (40517 lb)	19485** kg (42964 lb)	18545* kg (40892 lb)	19615** kg (43251 lb)
PERFORMANCE				
• Travel speed Forward 1st	3.9 km/h (2.4 MPH)			
2nd	6.8 km/h (4.2 MPH)			
3rd	10.6 km/h (6.6 MPH)			
Reverse 1st	5.0 km/h (3.1 MPH)			
2nd	8.6 km/h (5.3 MPH)			
3rd	13.4 km/h (8.3 MPH)			
• Maximum drawbar pull	22820 kg (50318 lb)			
ENGINE				
• Model	Komatsu 6D125-1 diesel engine	Komatsu S6D125-1 diesel engine		
• Flywheel horsepower	180 HP	190 HP		
• Starting motor	24 V 7.5 kW			
• Alternator	24 V 35 A			
• Battery	12V 140 Ah x 2 pieces			

*: Semi-U tiltdozer
 **: Straight-tilt dozer

**D65E-12
D65EX-12**

- **Machines equipped with tiltadozer**

The values without () are the values when the tiltadozer or semi-U blade are installed.
The values with () are the values only when the semi-U blade is installed.

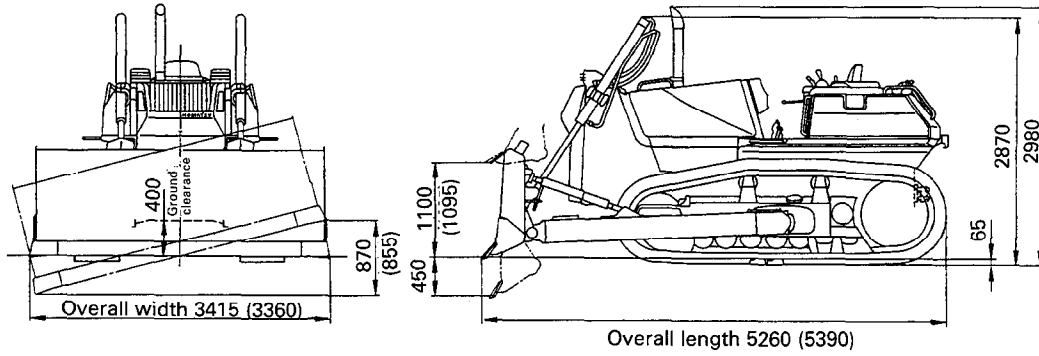

- **Machines equipped with angledozer**

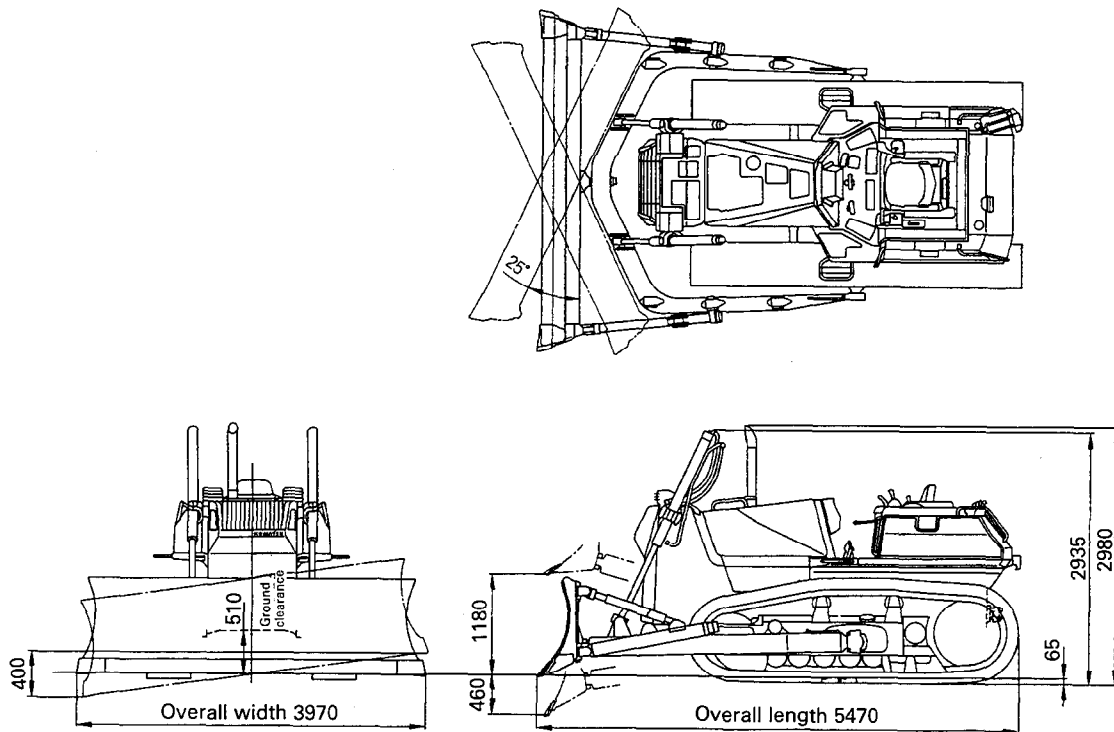

- With cab + ROPS canopy

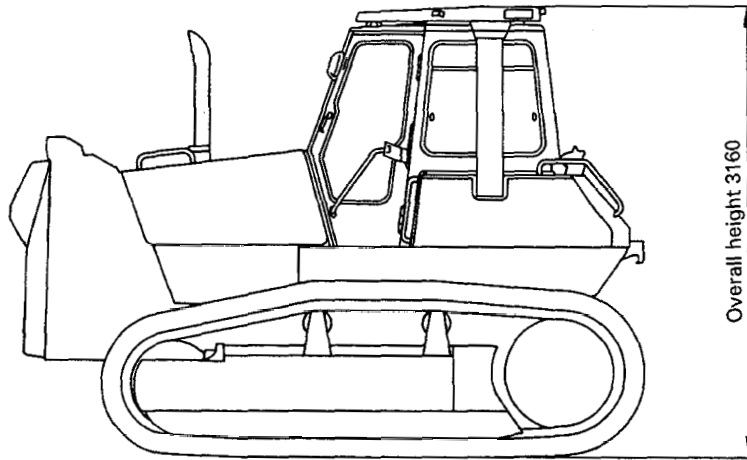

- With canopy

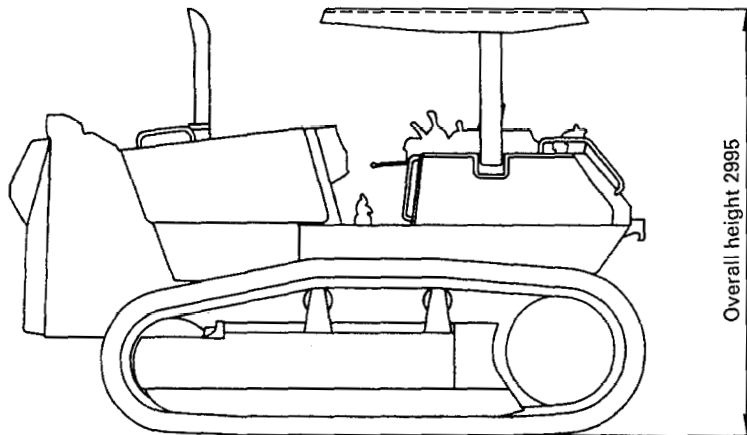

- With ROPS canopy

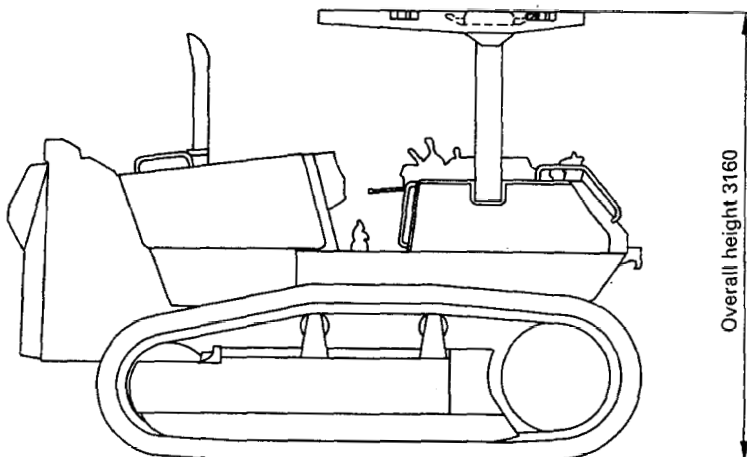

**D65P-12
D65PX-12**

- **Machines equipped with tiltdozer**

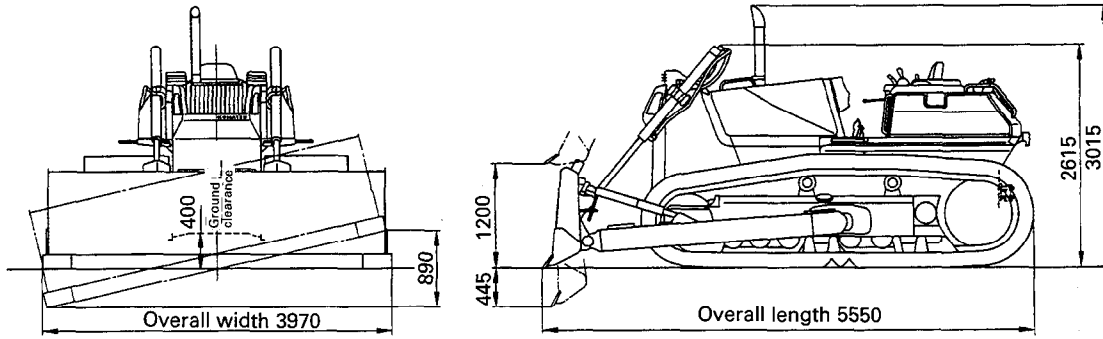

- **Machines equipped with power tilt, power pitch dozer**

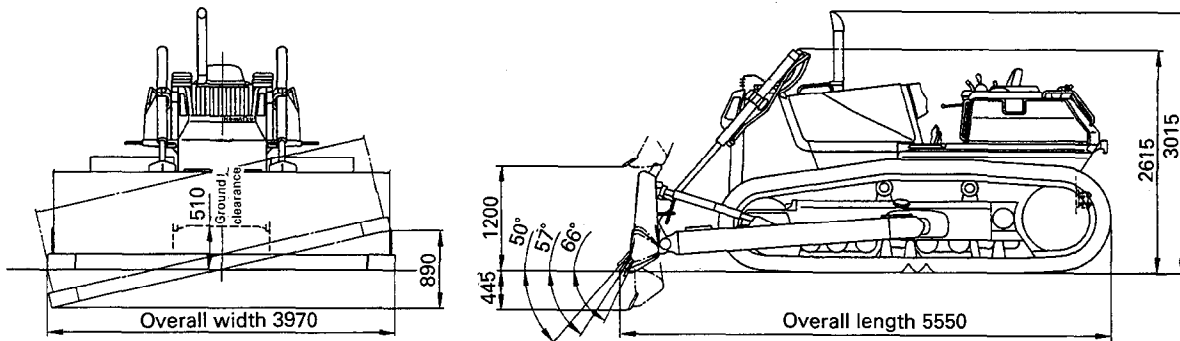

- With cab + ROPS canopy

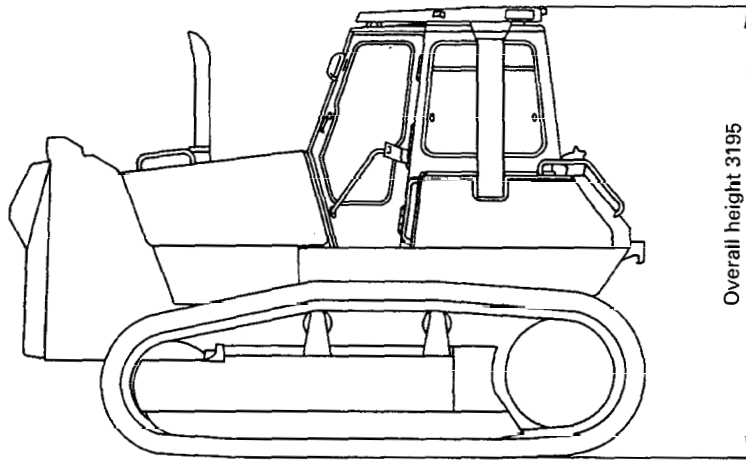

- With canopy

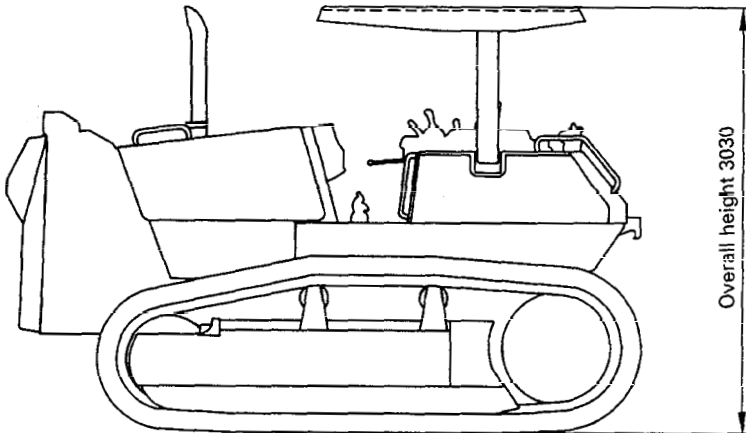

- With ROPS canopy

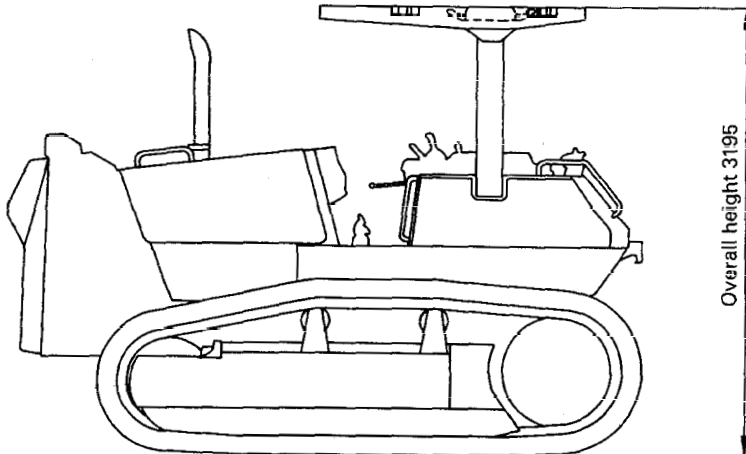

OPTIONS, ATTACHMENTS

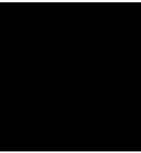

26. GENERAL PRECAUTIONS

26.1 PRECAUTIONS RELATED TO SAFETY

If attachments or options other than those authorized by Komatsu are installed, this will not only affect the life of the machine, but will also cause problems with safety.

When installing attachments not listed in this Operation and Maintenance Manual, please contact your Komatsu distributor first.

If you do not contact Komatsu, we cannot accept any responsibility for any accident or failure.

WARNING

Precautions for removal and installation operations

- **When removing or installing attachments, obey the following precautions and take care to ensure safety during the operation.**
- **Carry out the removal and installation operations on a flat, firm ground surface.**
- **When the operation is carried out by two or more workers, determine signals and follow these during the operation.**
- **When carrying heavy objects (more than 25 kg), use a crane.**
- **When removing heavy parts, always support the part before removing it.
When lifting such heavy parts with a crane, always pay careful attention to the position of the center of gravity.**
- **It is dangerous to carry out operations with the load kept suspended. Always set the load on a stand, and check that it is safe.**
- **When removing or installing attachments, make sure that they are in a stable condition and will not fall over.**
- **Never go under a load suspended from a crane.
Always stand in a position that is safe even if the load should fall.**

NOTICE

Qualifications are required to operate a crane. Never allow the crane to be operated by an unqualified person.

For details of the removal and installation operations, please contact your Komatsu distributor.

27. USING SEAT BELT

When operating a machine equipped with ROPS, be sure to use the seat belt.

- **Before fastening the seat belt, inspect the securing brackets and belt for abnormal conditions. Replace any worn or damaged seat belt or the securing brackets.**
- **Adjust and fasten the seat belt before operating the machine.**
- **Always use seat belt when operating the machine.**
- **Do not use seat belt with either half of the belt kinked.**

27.1 FASTEN THE BELT AND REMOVE IT IN THE FOLLOWING MANNER

1. Adjust the seat so that the brake pedal can be depressed all the way with the operator's back against the backrest.
2. After positioning the seat, adjust the tether belt ①. With the seat unoccupied, tense the belt slightly across the seat and install.
3. Sit in the seat. Hold buckle ② with your left hand and tongue ③ with your right hand, put the tongue into the buckle. Check that the belt has locked by pulling it.
4. When removing the belt, raise the tip of the buckle lever to release it.
Fasten belt along your body without kinking it. Adjust the lengths of the belt on both the buckle and the tongue sides so that the buckle is located at the mid-point of your body front.

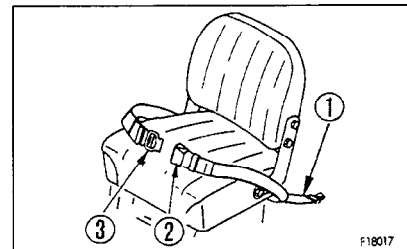

27.2 ADJUST THE BELT LENGTH IN THE FOLLOWING MANNER

27.2.1 TO SHORTEN THE BELT

Pull the free end of the belt on either the buckle body or tongue side.

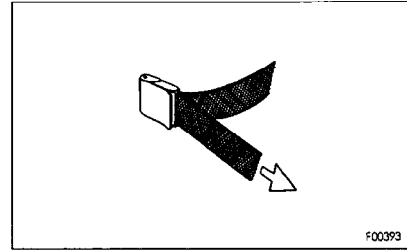

27.2.2 TO LENGTHEN THE BELT

Pull the belt while holding it at a right angle to buckle or tongue.

Inspect bolts and fittings on the chassis for tightness. Retighten any loose bolts to 2 to 3 kgm torque.

If the seat is scratched or frayed or if any of the fittings are broken or deformed from long service, replace the seat belt immediately.

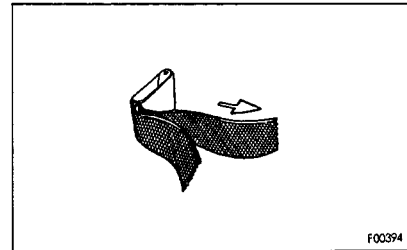

28. HANDLING DELUXE SEAT

⚠ WARNING

- Adjust the seat position at the beginning of each shift or when operators change.
- Adjust the seat so that the brake pedal can be depressed all the way with the operator's back against the backrest.

Ⓐ Fore-aft adjustment of seat

Move lever ① to the right set the seat to a position where it is easy to operate, then release the lever.

Fore-aft adjustment: 160 mm (9 stages)

Ⓑ Weight adjustment of seat

Turn knob ② under the seat to match the weight adjustment scale with your own weight.

The weight can be adjusted within a range of 50 – 120 kg.

REMARK

If you want to make the seat softer, turn the weight adjustment to a lower weight; if you want to make the seat harder, adjust to a higher weight.

When operating on uneven surfaces, adjust the seat to a harder setting.

Ⓒ Adjusting reclining angle

NOTICE

When reclining the seat back to the rear, check the space behind, and adjust to a suitable position.

Pull lever ③, set the seatback to a position where it is easy to operate, then release the lever.

Ⓓ Adjusting seat tilt

Pull up lever ④ to remove the lock, set the seat to the desired position, then release the lever to lock the seat in position.

Tilt adjustment: 13° up and down

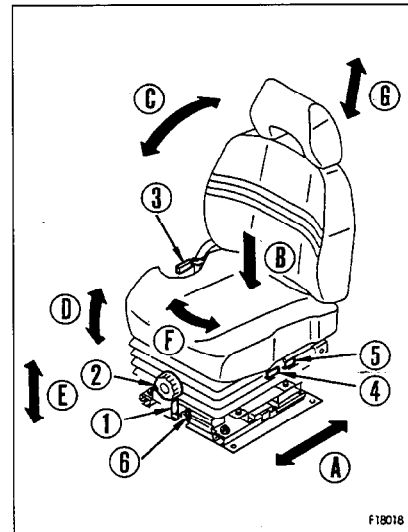

Ⓔ Height adjustment of seat

Pull levers ④ and ⑤ up at the same time to remove the lock, set the seat to the desired position, then release the lever to lock the seat in position.

Height adjustment: 65 mm

Ⓕ Adjusting direction of seat

When lever ⑥ is moved to the left, it is possible to turn the seat manually to the right to change the position by 15°.

After changing the direction of the seat, move the lever back securely and lock it.

Ⓖ Adjusting height of headrest

- To make it higher
Hold the headrest and pull it up.

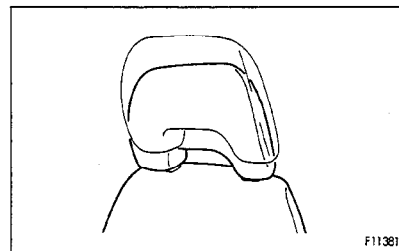

- To make it lower
Keep knob ⑦ pushed down, and push the headrest down to the desired position.
Height adjustment: 60 mm (2 stages)

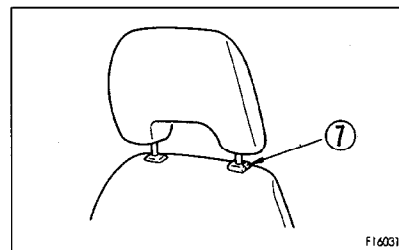

29. HANDLING ACCUMULATOR

WARNING

On machines equipped with an accumulator, for a short time after the engine is stopped, if the blade control lever is moved to the LOWER position, the work equipment will move down under its own weight.

After stopping the engine, always place the safety lever in the LOCK position.

The accumulator is filled with high-pressure nitrogen gas, and it is extremely dangerous if it is handled in the wrong way. Always observe the following precautions.

- Never make any hole in the accumulator or expose it to flame or fire.
- Do not weld any boss to the accumulator.
- When disposing of the accumulator, it is necessary to release the gas from the accumulator, so please contact your Komatsu distributor.

The accumulator is a device to store the pressure in the control circuit, and when it is installed, the control circuit can be operated for a short time even after the engine is stopped. Therefore, if the control lever is moved in the direction to lower the work equipment, it is possible for the work equipment to move under its own weight.

The accumulator is installed to the position shown in the diagram on the right.

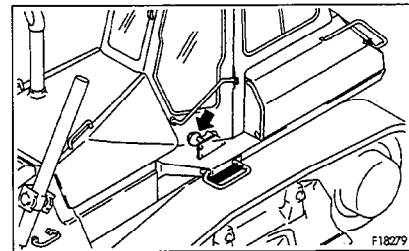

29.1 METHOD OF RELEASING PRESSURE IN OPERATING CIRCUIT ON MACHINE EQUIPPED WITH ACCUMULATOR

1. Lower the work equipment and stop the engine.
2. After stopping the engine, operate the control lever fully to the front, rear, left, and right to release the pressure inside the work equipment circuit.

However, the pressure cannot be completely removed, so when removing the work equipment circuit, loosen the screw slowly, and never stand in the direction where the oil spurts out.

